

SOLUTION

BENDING



HG ATC SERIES



HYBRID BENDING MACHINE WITH AUTOMATIC TOOL CHANGER



QMADA®

HG ATC SERIES

HYBRID BENDING MACHINE WITH AUTOMATIC TOOL CHANGER

VASTLY REDUCED DAILY SETUP TIMES RAPID TURNAROUND BETWEEN JOBS

AMADA engineered the HG-ATC as an ideal solution for variable lot sizes and complex tool layouts. The Automatic Tool Changer (ATC) can load even the most complex tool layout within three minutes and allows operators of varied experience levels to efficiently utilise this bending system.

The key benefits of the ATC are:

- Quick tool setups
- Four independent tool manipulators
- Automatic and safe tool locking by hydraulic clamps
- Possible reverse orientation of tools

Other standard features on the HG-ATC include:

- AMNC 3i: the latest touchscreen numerical control
- An integrated bend sensor that guarantees consistent bend angle accuracy
- A servo/hydraulic drive system that consumes less energy than a conventional press brake



TYPICAL PROCESSING SAMPLES

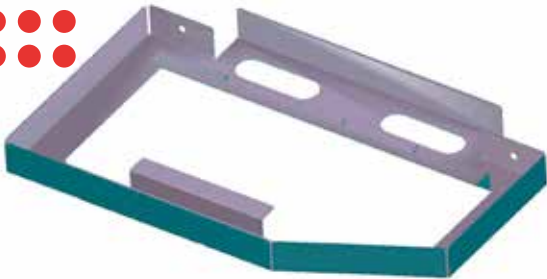

Machine: HG-1003 ATC
 Material: Zintec 1.0mm
 Total number of bends: 10
 Total number of tool station: 4

SETUP AND OPERATING TIME (10 parts)

45% SAVED TIME

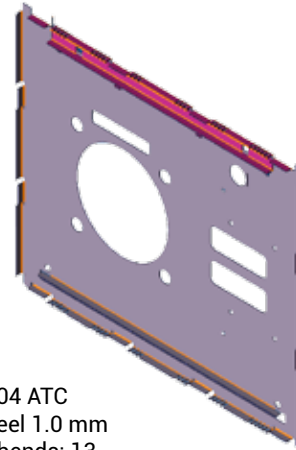
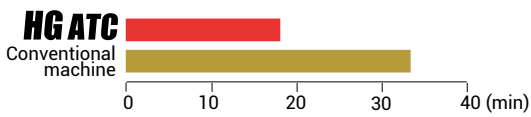

Machine: HG-2204 ATC
 Material: Mild Steel 1.0 mm
 Total number of bends: 13
 Total number of tool station: 19

SETUP AND OPERATING TIME (10 parts)

55% SAVED TIME

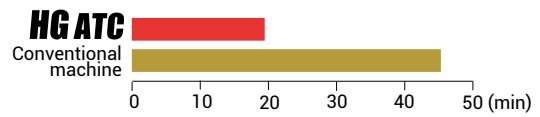

DAILY PRODUCTION EXAMPLE*



54% SAVED TIME

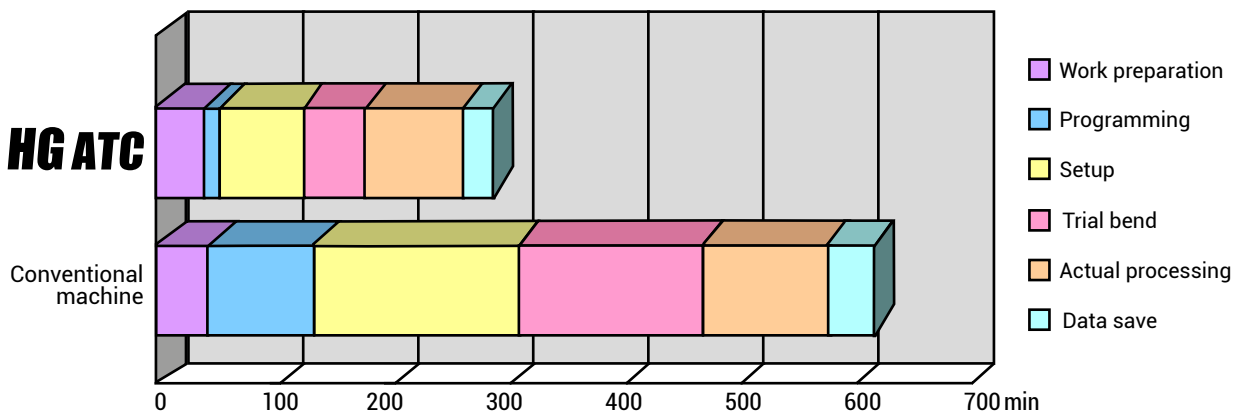

* Reported data are only for reference

HIGHLY ACCURATE BENDING FUNCTION

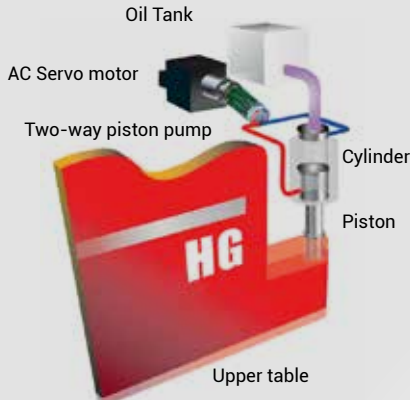

UNIQUE HYBRID DRIVE SYSTEM

Thanks to its independent AC-SERVO motor drive and its highly efficient bi-directional hydraulic pumps, the bending operation offers the following key benefits:

- Extremely fast approach, bending and return speeds provide faster cycle times and produce more parts per hour
- Unrivalled ram positioning and repeatability of ± 0.001 mm
- Programmable ram tilting and free off-center bending capacity allows for quick setup of multi-stage part bending
- Low power consumption: thanks to Hybrid technology, apparent power (kW) is reduced and, as the pump is activated on demand, it is more energy-efficient.
- Stable hydraulic oil temperature ensures consistent angular accuracy
- Less hydraulic oil and fewer oil changes are required
- Very low noise level

DYNAMIC HYDRAULIC CROWN BENDING

The hydraulic cylinders located in the lower beam of the machine automatically compensate for any upper beam deflection:

- Achieves consistent bend angles throughout the entire length of the machine
- Operators can program a complete workflow by staging multiple tool setups along the bed
- The crowning system is able to detect real force and can actively compensate for upper beam deflection

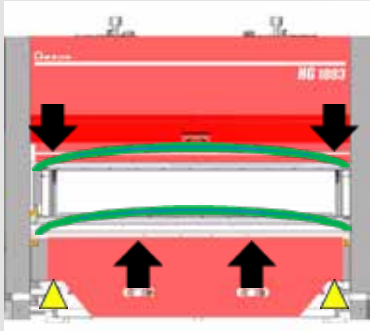

AUTOMATIC INTELLIGENT TOOLING SETUP



AUTOMATIC TOOL CHANGER

Equipped with an ATC (Automatic Tool Changer) the HG-ATC provides unmatched flexibility and productivity. The ATC is capable of storing 15 punches and 18 dies (1003 model) or 18 punches and 25 dies (2204 model). Locating and loading the appropriate tooling is quick and efficient. The system's four-axis manipulator precisely selects and places punches and dies from the tool magazine - avoiding costly delays typically associated with conventional tool changes. The manipulators can move independently and a clever algorithm guarantees the best setup time. HG-ATC features and benefits include:

- Much quicker and more precise tool setup compared to manual operation
- Possibility to introduce rush jobs seamlessly
- Perfect for small batch sizes and complex tool layouts
- Huge ergonomic advantage for the operator

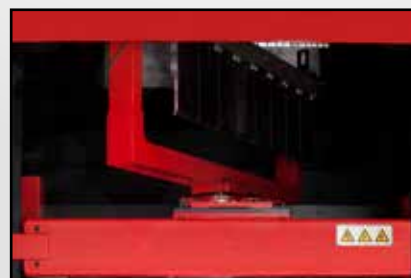

Rotating stockers enable punches to be installed in reverse orientation

BENDING PRECISION

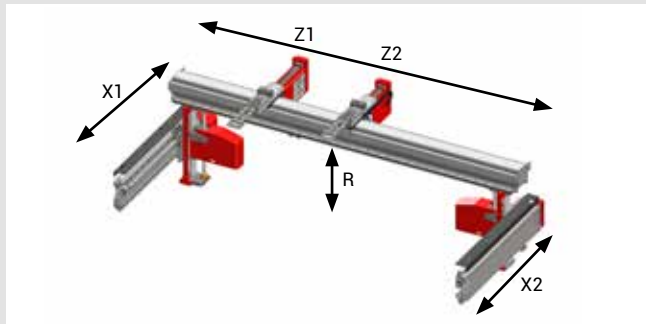

BACK GAUGE SYSTEM

Flexible, accurate and high performance back gauge, made of an extruded aluminium alloy and exclusively made for AMADA. The use of this technology allows a very light but strong and rigid moving element, giving maximum speed and maintaining long term accuracy.



DELTA X FINGERS

- A useful feature when bending asymmetrical work pieces
- A flexible position with pin exchange is possible



SENSOR FINGERS

- Eliminates gauging errors
- Sensor pauses the bend process if the part becomes separated from the gauge

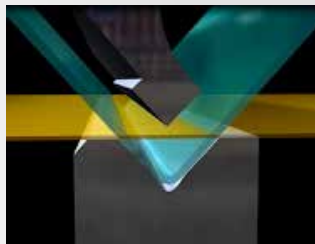

Thickness check

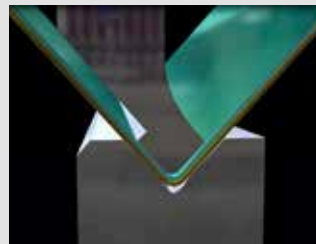

Constant result

THICKNESS DETECTION SYSTEM (TDS)

TDS detects variations in material thickness and automatically adjusts the bend position to provide accurate and stable bending results.

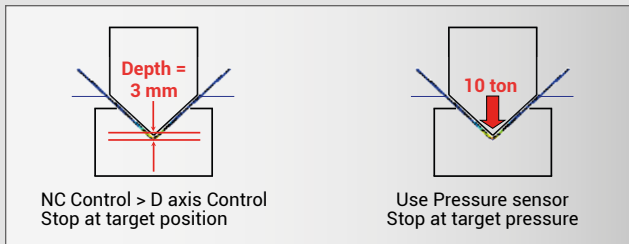

NC Control > D axis Control
Stop at target position

Position Control

Use Pressure sensor
Stop at target pressure

Force Control

FORCE CONTROL SYSTEM

Accurate bending is achieved by perfect force calculation and control. This function for angle control is possible with the correct tools and angle combination.



DIGIPRO

The AMADA Digipro is a highly-accurate, electronic angle-measuring device that transmits the measured angle wirelessly to the press brake's NC. The program is then automatically corrected as required, providing a precise bend angle.



Bi-S SYSTEM

This automatic angle-adjustment device ensures highly accurate bending even when material thickness and properties vary from part to part. This removes the need for test bending and adjustment of the initial bend angle, which eliminates scrap and reduces setup time.

EASY OPERATION



AMNC 3i

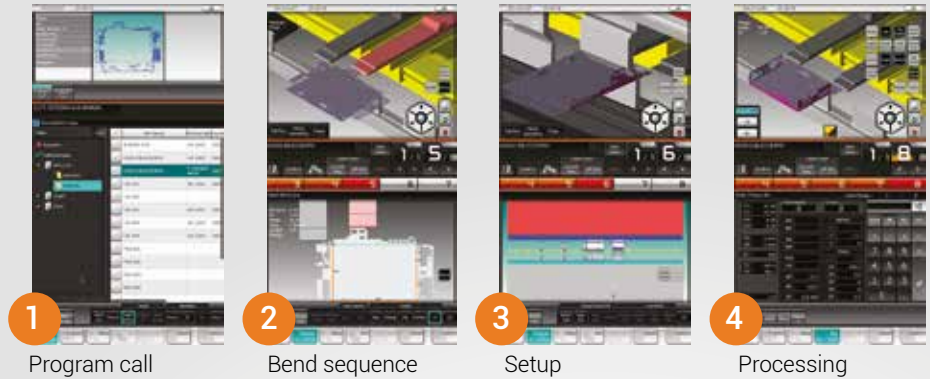

The AMNC 3i control is optimised for ease of use.

- The multi-touch LCD panel, with its user-friendly design, provides intuitive smartphone like operation
- The 18.5 inch vertical display means you can view all the necessary program and bend information on one screen

SAFETY AND SECURITY



Safety device

The machine is equipped with a laser security system (AKAS III) that is positioned automatically.



Safety door

During the automatic tool change, a vertical sliding door protects the operators. It is manually closed and opens automatically at the end of the tool loading cycle.

BENDING CAM SOFTWARE

CAD/CAM automatically selects tools, creates tool layouts and bend sequences.



Auto Batch Mode

CAM software creates programs without operator intervention.

Common Tool layout

CAM software proposes a common tool layout for a maximum of 99 parts.

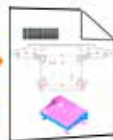

The AMNC 3i control uses offline programs to reduce setup time and increase machine efficiency.



VIRTUAL PROTOTYPE SIMULATION SYSTEM

VPSS 3i Bend is the Intelligent, Interactive and Integrated software environment that surrounds the new AMADA solutions. This system considers the complete assembly and manufacturing process from the very beginning.



OTHER FUNCTIONS AND OPTIONAL EQUIPMENT



Automatic slide foot pedal

- The bending control pedal moves according to the operators position to avoid manual repositioning; improving ergonomics and saving time



Hand wheel

- Easy adjustment of all axes
- Simple and flexible manual adjustments



Bar code reader

- Built-in bar code reader
- Eliminates program search time and errors



Hydraulic tool holder

- In case of manual setup:
- Front installation/front removal
 - No pipes on rear side



LED light (rear and front)

- LED lights are installed on each side of the upper beam to increase visibility of the work area



Die holder cleaning

- Integrated and automatic die holder cleaning guarantees a totally automatic tool changing solution

THE SHEET METAL DIGITAL FACTORY

AMADA proposes digital manufacturing using VPSS (Virtual Prototype Simulation System).

All data is created in the office and utilised in the workshop via a network.

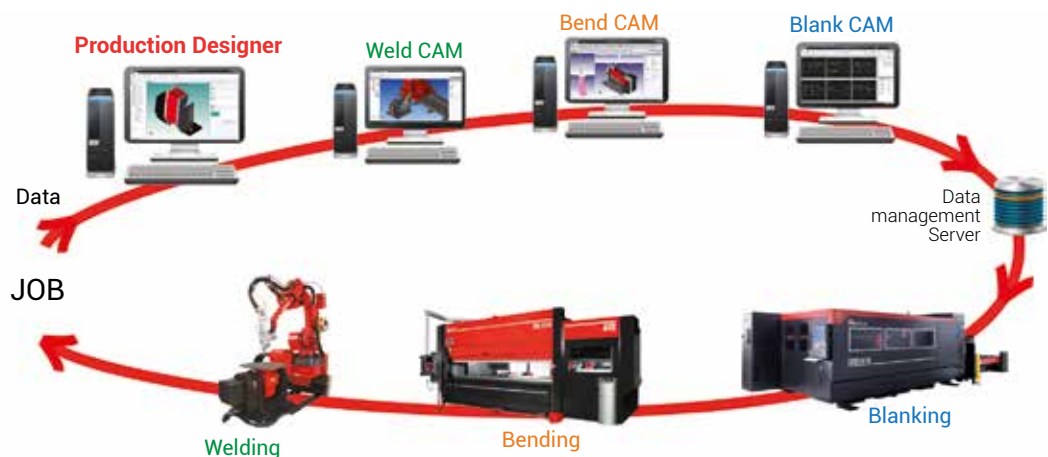

DIMENSIONS

HG-1003 ATC

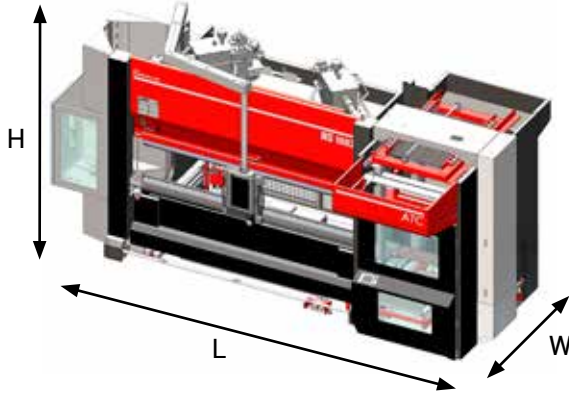

HG-2204 ATC

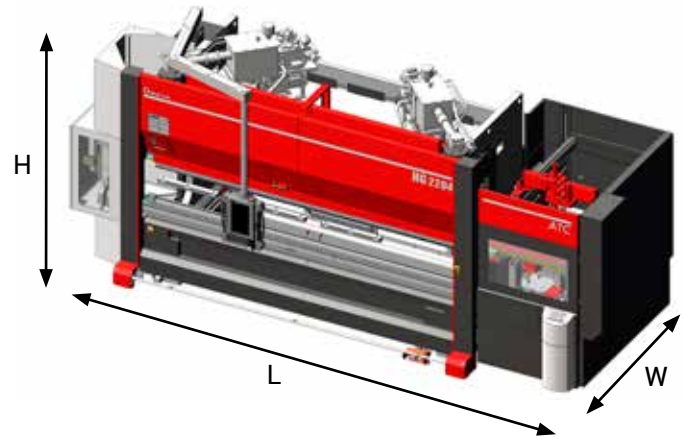

HG-ATC		1003	2204
Total length (L) + 1450 mm with NC arm opened	mm	6050	7125
Total width (W)	mm	3210	2528
Total height (H)	mm	2990	3335
Machine mass	kg	10500	22100

MACHINE SPECIFICATIONS

HG-ATC		1003	2204
Capacity	kN	1000	2200
Beam length	mm	3110	4300
Table width	mm	60	90
Distance between frames	mm	2700	3760
Throat depth	mm	450	450
Open height (with punch holders)	mm	596 (436)	596 (436)
Stroke	mm	250	250
Working height	mm	984	989
Number of crowning cylinders		2	3
Maximum approach speed	mm/s	200	200
Maximum bending speed	mm/s	20	20
Maximum return speed	mm/s	250	250

ATC SPECIFICATIONS

HG-ATC		1003	2204
Tool clamp		AMTS III	AMTS III
Tool holder length	mm	3060	4250
Number of tool stockers (dies)		18	25
Number of tool stockers (punch)		15	18
Tool layout length	mm	15~3000	15~4000
Tool length increments	mm	5	5

Specifications, appearance and equipment are subject to vary without notice by reason of improvement or regional requirement.



For Your Safe Use

Be sure to read the operator's manual carefully before use.

When using this product, appropriate personal protection equipment must be used.

The official model name of machine described in this catalogue is HG. Use the registered model name when you contact the authorities for applying for installation, exporting, or financing. The hyphenated spelling HG SERIES is used in some portions of this catalogue for ease of readability. Hazard prevention measures are removed in the photos used in this catalogue.

AMADA UK LTD.

Spennells Valley Road,
Kidderminster,
Worcestershire DY10 1XS
United Kingdom
Tel: +44 (0)1562 749500
Fax: +44 (0)1562 749510
www.amada.co.uk

AMADA SA

Paris Nord II
96, avenue de la Pyramide
F-93290 Tremblay
France
Tél : +33 (0)149903000
Fax : +33 (0)149903199
www.amada.fr

AMADA GmbH

AMADA Allee 1
42781 Haan
Germany
Tel: +49 (0)2104 2126-0
Fax: +49 (0)2104 2126-999
www.amada.de

AMADA ITALIA S.r.l.

Via AMADA I., 1/3
29010 Pontenure (PC)
Italia
Tel: +39 (0)523-872111
Fax: +39 (0)523-872101
www.amada.it

