

# SOLUTION

KANTEN

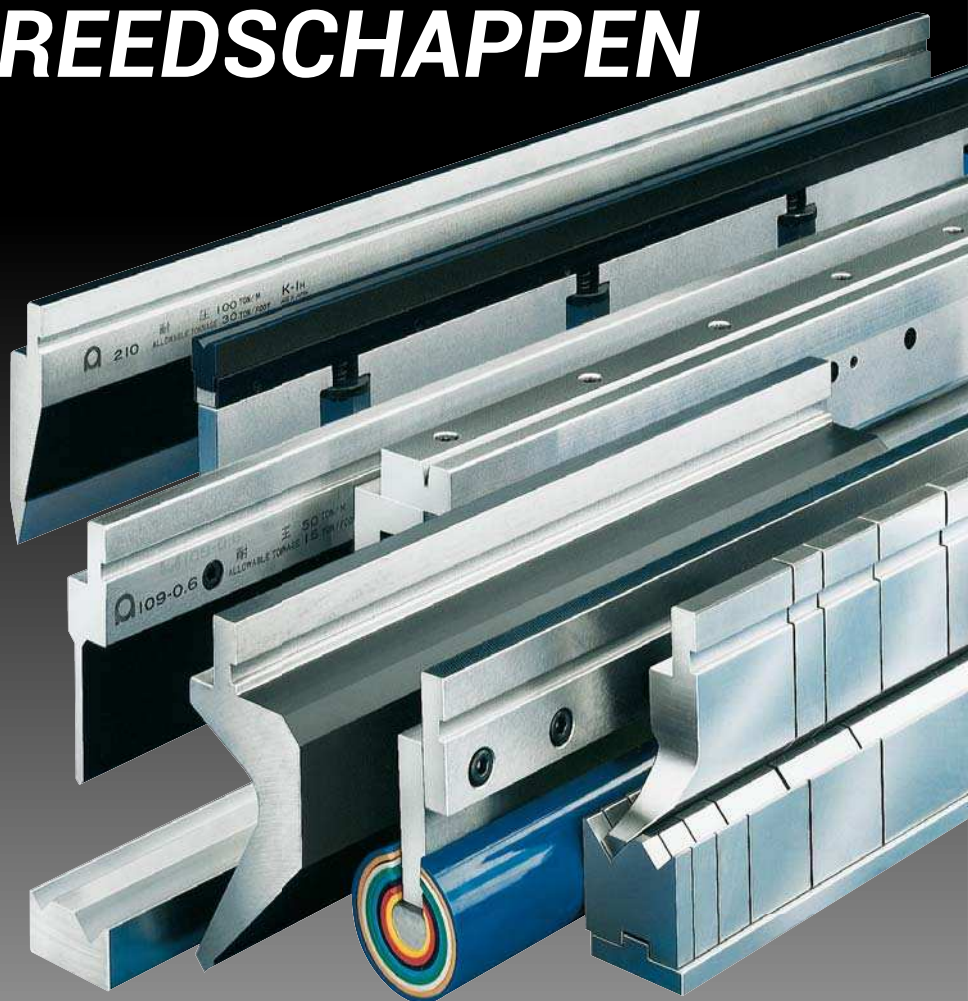

## KANTGEREEDSCHAPPEN



AMTS

 **AMADA**

---

## Inhoud

Inhoud	2
bending_tools	3
Bovenstempel	3
30° Bovenstempel	3
88° Bovenstempel	6
90° Bovenstempel	14
Matrijs	22
1V / 30°	22
1V / 88°	23
1V / 90°	29
Air bending force chart	35
Mild steel	35
Stainless steel	36

Optimal protection & highest wear resistance



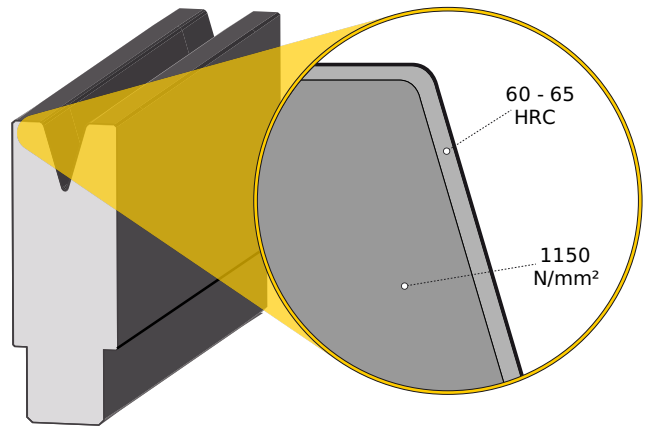

AMANIT® Press Brake Toolings have the best qualities for applications where very high wear and extreme load bearing occur.

- provides highest wear resistance on the tool surface (HRC 60-65)
- lowers the friction on the shoulder radii (by compound layer lubricity)
- has high tensile strength - 1150 N/mm<sup>2</sup>
- adds corrosion resistance to tooling



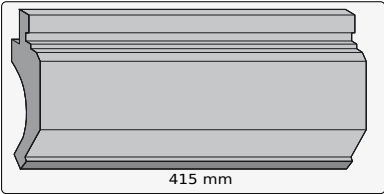
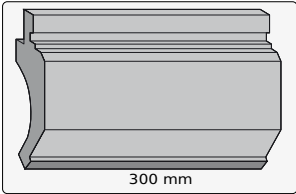
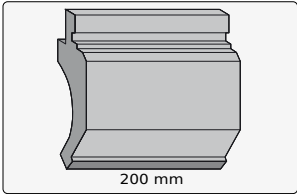
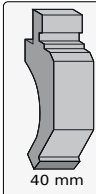

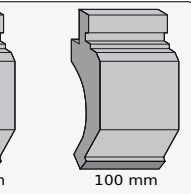
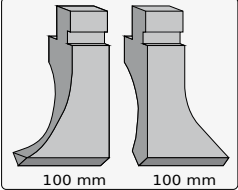
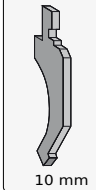

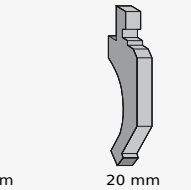

Tool type	Tip Angle	Maximum pressure	Production date
 835	00406 88°	ALLOWABLE TONNAGE MAX: 1000kN/m {100 ton/m} MAX: 30 TON/FOOT	A-8A MADE IN AUSTRIA
Length mm (inch)	Tip radius / V-Size mm (inch)		Country of origin
	R0.6 (.024) (32.874)		

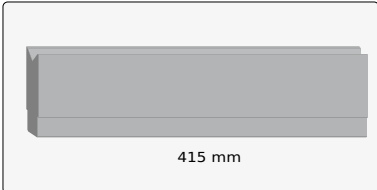
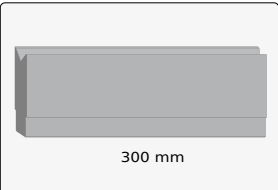
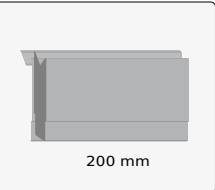
Available punching lengths

Long	Short	Sectionalized	Extra short	Ear
415 mm	300 mm	235 mm	200 mm	100 mm
			  	
			  	

Available die lengths

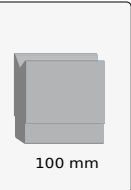
Long	Short	Sectionalized	Extra short
415 mm	300 mm	235 mm	200 mm
			     

## 30° Spits bovenstempel - MT 36

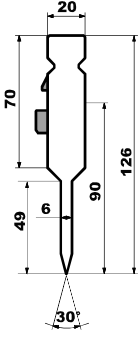

Hoek	30°
Hoogte	90.00 mm
Belasting	500 kN/m
Ear pressure	190 kN/m
Materiaal	
Hardheid	52 - 56 HRC

Radius 0.2 mm

	Lengte	Bestelnummer		Gewicht
Lang	415 mm	36230A	6H MT36230A	5.60 kg
Kort	300 mm	36230D	6H MT36230D	-
Gedeeld	235 mm	36230F	6H MT36230F	-
Kort-Gedeeld	200 mm	36230C	6H MT36230C	-
Hoorn	100 mm	36230G	6H MT36230G	-

Radius 0.6 mm

	Lengte	Bestelnummer		Gewicht
Lang	415 mm	36630A	6H MT36630A	5.60 kg
Kort	300 mm	36630D	6H MT36630D	-
Gedeeld	235 mm	36630F	6H MT36630F	-
Kort-Gedeeld	200 mm	36630C	6H MT36630C	-
Hoorn	100 mm	36630G	6H MT36630G	-

## 30° Spits bovenstempel - MT 36

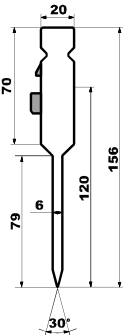

Hoek	30°
Hoogte	120.00 mm
Belasting	500 kN/m
Ear pressure	190 kN/m
Materiaal	
Hardheid	52 - 56 HRC

Radius 0.2 mm

	Lengte	Bestelnummer		Gewicht
Lang	415 mm	36232A	6H MT36232A	6.20 kg
Kort	300 mm	36232D	6H MT36232D	-
Gedeeld	235 mm	36232F	6H MT36232F	-
Kort-Gedeeld	200 mm	36232C	6H MT36232C	-
Hoorn	100 mm	36232G	6H MT36232G	-

Radius 0.6 mm

	Lengte	Bestelnummer		Gewicht
Lang	415 mm	36632A	6H MT36632A	6.20 kg
Kort	300 mm	36632D	6H MT36632D	-
Gedeeld	235 mm	36632F	6H MT36632F	-
Kort-Gedeeld	200 mm	36632C	6H MT36632C	-
Hoorn	100 mm	36632G	6H MT36632G	-

## 30° Spits bovenstempel - MT 36

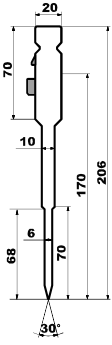

Hoek	30°
Hoogte	170.00 mm
Belasting	500 kN/m
Ear pressure	190 kN/m
Materiaal	
Hardheid	52 - 56 HRC

Radius 0.2 mm

	Lengte	Bestelnummer		Gewicht
Lang	415 mm	36237A	6H MT36237A	8.00 kg
Kort	300 mm	36237D	6H MT36237D	-
Gedeeld	235 mm	36237F	6H MT36237F	-
Kort-Gedeeld	200 mm	36237C	6H MT36237C	-
Hoorn	100 mm	36237G	6H MT36237G	-

Radius 0.6 mm

	Lengte	Bestelnummer		Gewicht
Lang	415 mm	36637A	6H MT36637A	8.00 kg
Kort	300 mm	36637D	6H MT36637D	-
Gedeeld	235 mm	36637F	6H MT36637F	-
Kort-Gedeeld	200 mm	36637C	6H MT36637C	-
Hoorn	100 mm	36637G	6H MT36637G	-

## 88° Standaard bovenstempel - MT 12

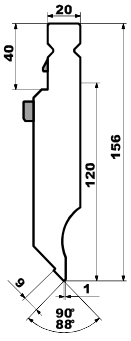

Hoek	88°
Hoogte	120.00 mm
Belasting	800 kN/m
Ear pressure	450 kN/m
Materiaal	
Hardheid	52 - 56 HRC

Radius 0.2 mm

	Lengte	Bestelnummer		Gewicht
Lang	415 mm	12282A	6H MT12282A	11.30 kg
Kort	300 mm	12282D	6H MT12282D	-
Gedeeld	235 mm	12282F	6H MT12282F	-
Kort-Gedeeld	200 mm	12282C	6H MT12282C	-
Hoorn	100 mm	12282G	6H MT12282G	-

Radius 0.6 mm

	Lengte	Bestelnummer		Gewicht
Lang	415 mm	12682A	6H MT12682A	11.30 kg
Kort	300 mm	12682D	6H MT12682D	-
Gedeeld	235 mm	12682F	6H MT12682F	-
Kort-Gedeeld	200 mm	12682C	6H MT12682C	-
Hoorn	100 mm	12682G	6H MT12682G	-

## 88° Standaard bovenstempel - MT 12

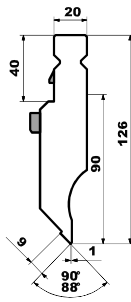

Hoek	88°
Hoogte	90.00 mm
Belasting	800 kN/m
Ear pressure	450 kN/m
Materiaal	
Hardheid	52 - 56 HRC

Radius 0.2 mm

	Lengte	Bestelnummer		Gewicht
Lang	415 mm	12280A	6H MT12280A	8.50 kg
Kort	300 mm	12280D	6H MT12280D	-
Gedeeld	235 mm	12280F	6H MT12280F	-
Kort-Gedeeld	200 mm	12280C	6H MT12280C	-
Hoorn	100 mm	12280G	6H MT12280G	-

Radius 0.6 mm

	Lengte	Bestelnummer		Gewicht
Lang	415 mm	12680A	6H MT12680A	8.50 kg
Kort	300 mm	12680D	6H MT12680D	-
Gedeeld	235 mm	12680F	6H MT12680F	-
Kort-Gedeeld	200 mm	12680C	6H MT12680C	-
Hoorn	100 mm	12680G	6H MT12680G	-

## 88° Standaard bovenstempel - MT 14

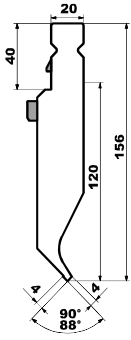

Hoek	88°
Hoogte	120.00 mm
Belasting	200 kN/m
Ear pressure	200 kN/m
Materiaal	
Hardheid	52 - 56 HRC

Radius 0.2 mm

	Lengte	Bestelnummer		Gewicht
Lang	415 mm	14282A	6H MT14282A	10.90 kg
Kort	300 mm	14282D	6H MT14282D	-
Gedeeld	235 mm	14282F	6H MT14282F	-
Kort-Gedeeld	200 mm	14282C	6H MT14282C	-
Hoorn	100 mm	14282G	6H MT14282G	-

Radius 0.6 mm

	Lengte	Bestelnummer		Gewicht
Lang	415 mm	14682A	6H MT14682A	10.90 kg
Kort	300 mm	14682D	6H MT14682D	-
Gedeeld	235 mm	14682F	6H MT14682F	-
Kort-Gedeeld	200 mm	14682C	6H MT14682C	-
Hoorn	100 mm	14682G	6H MT14682G	-

## 88° Standaard bovenstempel - MT 14

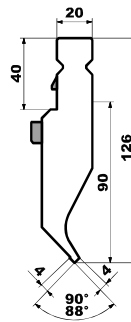

Hoek	88°
Hoogte	90.00 mm
Belasting	200 kN/m
Ear pressure	200 kN/m
Materiaal	
Hardheid	52 - 56 HRC

Radius 0.2 mm

	Lengte	Bestelnummer		Gewicht
Lang	415 mm	14280A	6H MT14280A	8.20 kg
Kort	300 mm	14280D	6H MT14280D	-
Gedeeld	235 mm	14280F	6H MT14280F	-
Kort-Gedeeld	200 mm	14280C	6H MT14280C	-
Hoorn	100 mm	14280G	6H MT14280G	-

Radius 0.6 mm

	Lengte	Bestelnummer		Gewicht
Lang	415 mm	14680A	6H MT14680A	8.20 kg
Kort	300 mm	14680D	6H MT14680D	-
Gedeeld	235 mm	14680F	6H MT14680F	-
Kort-Gedeeld	200 mm	14680C	6H MT14680C	-
Hoorn	100 mm	14680G	6H MT14680G	-

## 88° Spits bovenstempel - MT 30 (Straight Punch)

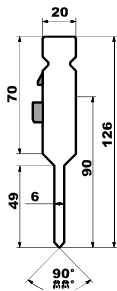

Hoek	88°
Hoogte	90.00 mm
Belasting	500 kN/m
Ear pressure	190 kN/m
Materiaal	
Hardheid	52 - 56 HRC

Radius 0.2 mm

	Lengte	Bestelnummer		Gewicht
Lang	415 mm	30280A	6H MT30280A	5.70 kg
Kort	300 mm	30280D	6H MT30280D	-
Gedeeld	235 mm	30280F	6H MT30280F	-
Kort-Gedeeld	200 mm	30280C	6H MT30280C	-
Hoorn	100 mm	30280G	6H MT30280G	-

Radius 0.6 mm

	Lengte	Bestelnummer		Gewicht
Lang	415 mm	30680A	6H MT30680A	5.70 kg
Kort	300 mm	30680D	6H MT30680D	-
Gedeeld	235 mm	30680F	6H MT30680F	-
Kort-Gedeeld	200 mm	30680C	6H MT30680C	-
Hoorn	100 mm	30680G	6H MT30680G	-

## 88° Standaard bovenstempel - MT 10

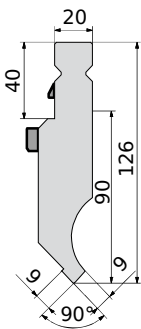

Hoek	88°
Hoogte	90.00 mm
Belasting	1000 kN/m
Ear pressure	450 kN/m
Materiaal	
Hardheid	52 - 56 HRC

Radius 0.2 mm

	Lengte	Bestelnummer		Gewicht
Lang	415 mm	10280A	6H MT10280A	8.60 kg
Kort	300 mm	10280D	6H MT10280D	-
Gedeeld	235 mm	10280F	6H MT10280F	-
Kort-Gedeeld	200 mm	10280C	6H MT10280C	-
Hoorn	100 mm	10280G	6H MT10280G	-

Radius 0.6 mm

	Lengte	Bestelnummer		Gewicht
Lang	415 mm	10680A	6H MT10680A	8.60 kg
Kort	300 mm	10680D	6H MT10680D	-
Gedeeld	235 mm	10680F	6H MT10680F	-
Kort-Gedeeld	200 mm	10680C	6H MT10680C	-
Hoorn	100 mm	10680G	6H MT10680G	-



## 88° Standaard bovenstempel - MT 28 (splayed)

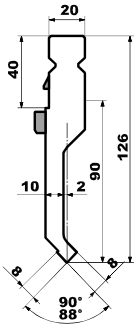

Hoek	88°
Hoogte	90.00 mm
Belasting	300 kN/m
Ear pressure	300 kN/m
Materiaal	
Hardheid	52 - 56 HRC

Radius 0.2 mm

	Lengte	Bestelnummer		Gewicht
Lang	415 mm	28280A	6H MT28280A	5.90 kg
Kort	300 mm	28280D	6H MT28280D	-
Gedeeld	235 mm	28280F	6H MT28280F	-
Kort-Gedeeld	200 mm	28280C	6H MT28280C	-
Hoorn	100 mm	28280G	6H MT28280G	-

Radius 0.6 mm

	Lengte	Bestelnummer		Gewicht
Lang	415 mm	28680A	6H MT28680A	5.90 kg
Kort	300 mm	28680D	6H MT28680D	-
Gedeeld	235 mm	28680F	6H MT28680F	-
Kort-Gedeeld	200 mm	28680C	6H MT28680C	-
Hoorn	100 mm	28680G	6H MT28680G	-

## 88° Zwanenhals bovenstempel - MT 47

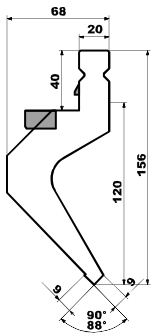

Hoek	88°
Hoogte	120.00 mm
Belasting	500 kN/m
Ear pressure	500 kN/m
Materiaal	
Hardheid	52 - 56 HRC

Radius 0.2 mm

	Lengte	Bestelnummer		Gewicht
Lang	835 mm	1A5211	1A5211	-
Kort	415 mm	1A5212	1A5212	-
Gedeeld	835 mm	1A521A	1A521A	-

Radius 0.6 mm

	Lengte	Bestelnummer		Gewicht
Lang	835 mm	1A5251	1A5251	-
Kort	415 mm	1A5252	1A5252	-
Gedeeld	835 mm	1A525A	1A525A	-

## 88° Spits bovenstempel - MT 30 (Straight Punch)

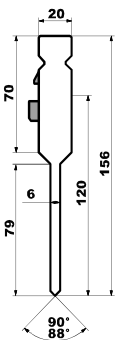

Hoek	88°
Hoogte	120.00 mm
Belasting	500 kN/m
Ear pressure	190 kN/m
Materiaal	
Hardheid	52 - 56 HRC

Radius 0.2 mm

	Lengte	Bestelnummer		Gewicht
Lang	415 mm	30282A	6H MT30282A	6.30 kg
Kort	300 mm	30282D	6H MT30282D	-
Gedeeld	235 mm	30282F	6H MT30282F	-
Kort-Gedeeld	200 mm	30282C	6H MT30282C	-
Hoorn	100 mm	30282G	6H MT30282G	-

Radius 0.6 mm

	Lengte	Bestelnummer		Gewicht
Lang	415 mm	30682A	6H MT30682A	6.30 kg
Kort	300 mm	30682D	6H MT30682D	-
Gedeeld	235 mm	30682F	6H MT30682F	-
Kort-Gedeeld	200 mm	30682C	6H MT30682C	-
Hoorn	100 mm	30682G	6H MT30682G	-

## 88° Spits bovenstempel - MT 30 (Straight Punch)

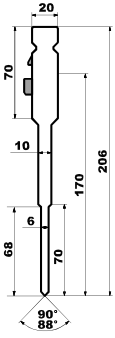

Hoek	88°
Hoogte	170.00 mm
Belasting	500 kN/m
Ear pressure	190 kN/m
Materiaal	
Hardheid	52 - 56 HRC

Radius 0.2 mm

	Lengte	Bestelnummer		Gewicht
Lang	415 mm	30287A	6H MT30287A	8.10 kg
Kort	300 mm	30287D	6H MT30287D	-
Gedeeld	235 mm	30287F	6H MT30287F	-
Kort-Gedeeld	200 mm	30287C	6H MT30287C	-
Hoorn	100 mm	30287G	6H MT30287G	-

Radius 0.6 mm

	Lengte	Bestelnummer		Gewicht
Lang	415 mm	30687A	6H MT30687A	8.10 kg
Kort	300 mm	30687D	6H MT30687D	-
Gedeeld	235 mm	30687F	6H MT30687F	-
Kort-Gedeeld	200 mm	30687C	6H MT30687C	-
Hoorn	100 mm	30687G	6H MT30687G	-

## 88° Standaard bovenstempel - MT 10

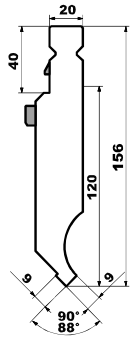

Hoek	88°
Hoogte	120.00 mm
Belasting	1000 kN/m
Ear pressure	450 kN/m
Materiaal	
Hardheid	52 - 56 HRC

Radius 0.2 mm

	Lengte	Bestelnummer		Gewicht
Lang	415 mm	10282A	6H MT10282A	11.40 kg
Kort	300 mm	10282D	6H MT10282D	-
Gedeeld	235 mm	10282F	6H MT10282F	-
Kort-Gedeeld	200 mm	10282C	6H MT10282C	-
Hoorn	100 mm	10282G	6H MT10282G	-

Radius 0.6 mm

	Lengte	Bestelnummer		Gewicht
Lang	415 mm	10682A	6H MT10682A	11.40 kg
Kort	300 mm	10682D	6H MT10682D	-
Gedeeld	235 mm	10682F	6H MT10682F	-
Kort-Gedeeld	200 mm	10682C	6H MT10682C	-
Hoorn	100 mm	10682G	6H MT10682G	-

## 88° Standaard bovenstempel - MT 28 (splayed)

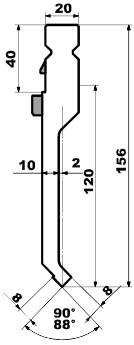

Hoek	88°
Hoogte	120.00 mm
Belasting	300 kN/m
Ear pressure	300 kN/m
Materiaal	
Hardheid	52 - 56 HRC

Radius 0.2 mm

	Lengte	Bestelnummer		Gewicht
Lang	415 mm	28282A	6H MT28282A	6.90 kg
Kort	300 mm	28282D	6H MT28282D	-
Gedeeld	235 mm	28282F	6H MT28282F	-
Kort-Gedeeld	200 mm	28282C	6H MT28282C	-
Hoorn	100 mm	28282G	6H MT28282G	-

Radius 0.6 mm

	Lengte	Bestelnummer		Gewicht
Lang	415 mm	28682A	6H MT28682A	6.90 kg
Kort	300 mm	28682D	6H MT28682D	-
Gedeeld	235 mm	28682F	6H MT28682F	-
Kort-Gedeeld	200 mm	28682C	6H MT28682C	-
Hoorn	100 mm	28682G	6H MT28682G	-

## 88° Standaard bovenstempel - MT 28 (splayed)

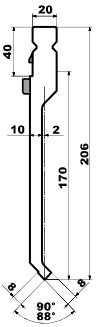

Hoek	88°
Hoogte	170.00 mm
Belasting	300 kN/m
Ear pressure	300 kN/m
Materiaal	
Hardheid	52 - 56 HRC

Radius 0.2 mm

	Lengte	Bestelnummer		Gewicht
Lang	415 mm	28287A	6H MT28287A	8.60 kg
Kort	300 mm	28287D	6H MT28287D	-
Gedeeld	235 mm	28287F	6H MT28287F	-
Kort-Gedeeld	200 mm	28287C	6H MT28287C	-
Hoorn	100 mm	28287G	6H MT28287G	-

Radius 0.6 mm

	Lengte	Bestelnummer		Gewicht
Lang	415 mm	28687A	6H MT28687A	8.60 kg
Kort	300 mm	28687D	6H MT28687D	-
Gedeeld	235 mm	28687F	6H MT28687F	-
Kort-Gedeeld	200 mm	28687C	6H MT28687C	-
Hoorn	100 mm	28687G	6H MT28687G	-

## 88° Standaard bovenstempel - MT 40

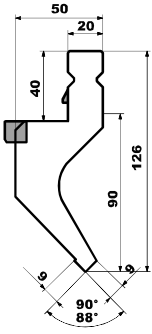

Hoek	88°
Hoogte	90.00 mm
Belasting	700 kN/m
Ear pressure	500 kN/m
Materiaal	
Hardheid	52 - 56 HRC

Radius 0.2 mm

	Lengte	Bestelnummer		Gewicht
Lang	415 mm	40280A	6H MT40280A	9.60 kg
Kort	300 mm	40280D	6H MT40280D	-
Gedeeld	235 mm	40280F	6H MT40280F	-
Kort-Gedeeld	200 mm	40280C	6H MT40280C	-
Hoorn	100 mm	40280G	6H MT40280G	-

Radius 0.6 mm

	Lengte	Bestelnummer		Gewicht
Lang	415 mm	40680A	6H MT40680A	9.60 kg
Kort	300 mm	40680D	6H MT40680D	-
Gedeeld	235 mm	40680F	6H MT40680F	-
Kort-Gedeeld	200 mm	40680C	6H MT40680C	-
Hoorn	100 mm	40680G	6H MT40680G	-

## 88° Zwanenhals bovenstempel - MT 46

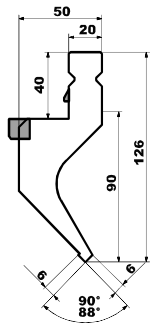

Hoek	88°
Hoogte	90.00 mm
Belasting	500 kN/m
Ear pressure	350 kN/m
Materiaal	
Hardheid	52 - 56 HRC

Radius 0.2 mm

	Lengte	Bestelnummer		Gewicht
Lang	415 mm	46280A	6H MT46280A	9.10 kg
Kort	300 mm	46280D	6H MT46280D	-
Gedeeld	235 mm	46280F	6H MT46280F	-
Kort-Gedeeld	200 mm	46280C	6H MT46280C	-
Hoorn	100 mm	46280G	6H MT46280G	-

Radius 0.6 mm

	Lengte	Bestelnummer		Gewicht
Lang	415 mm	46680A	6H MT46680A	9.10 kg
Kort	300 mm	46680D	6H MT46680D	-
Gedeeld	235 mm	46680F	6H MT46680F	-
Kort-Gedeeld	200 mm	46680C	6H MT46680C	-
Hoorn	100 mm	46680G	6H MT46680G	-

## 88° Standaard bovenstempel - MT 40

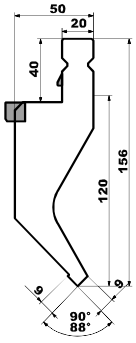

Hoek	88°
Hoogte	120.00 mm
Belasting	700 kN/m
Ear pressure	500 kN/m
Materiaal	
Hardheid	52 - 56 HRC

Radius 0.2 mm

	Lengte	Bestelnummer		Gewicht
Lang	415 mm	40282A	6H MT40282A	13.80 kg
Kort	300 mm	40282D	6H MT40282D	-
Gedeeld	235 mm	40282F	6H MT40282F	-
Kort-Gedeeld	200 mm	40282C	6H MT40282C	-
Hoorn	100 mm	40282G	6H MT40282G	-

Radius 0.6 mm

	Lengte	Bestelnummer		Gewicht
Lang	415 mm	40682A	6H MT40682A	13.80 kg
Kort	300 mm	40682D	6H MT40682D	-
Gedeeld	235 mm	40682F	6H MT40682F	-
Kort-Gedeeld	200 mm	40682C	6H MT40682C	-
Hoorn	100 mm	40682G	6H MT40682G	-

## 88° Zwanenhals bovenstempel - MT 46

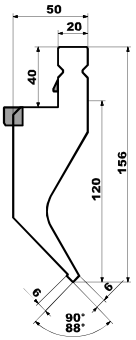

Hoek	88°
Hoogte	120.00 mm
Belasting	500 kN/m
Ear pressure	350 kN/m
Materiaal	
Hardheid	52 - 56 HRC

Radius 0.2 mm

	Lengte	Bestelnummer		Gewicht
Lang	415 mm	46282A	6H MT46282A	13.30 kg
Kort	300 mm	46282D	6H MT46282D	-
Gedeeld	235 mm	46282F	6H MT46282F	-
Kort-Gedeeld	200 mm	46282C	6H MT46282C	-
Hoorn	100 mm	46282G	6H MT46282G	-

Radius 0.6 mm

	Lengte	Bestelnummer		Gewicht
Lang	415 mm	46682A	6H MT46682A	13.30 kg
Kort	300 mm	46682D	6H MT46682D	-
Gedeeld	235 mm	46682F	6H MT46682F	-
Kort-Gedeeld	200 mm	46682C	6H MT46682C	-
Hoorn	100 mm	46682G	6H MT46682G	-

## 90° Standaard bovenstempel - MT 12

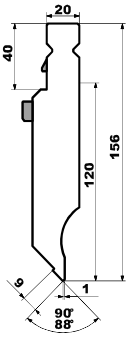

Hoek	90°
Hoogte	120.00 mm
Belasting	800 kN/m
Ear pressure	450 kN/m
Materiaal	
Hardheid	52 - 56 HRC

Radius 0.2 mm

	Lengte	Bestelnummer		Gewicht
Lang	415 mm	12202A	6H MT12202A	11.30 kg
Kort	300 mm	12202D	6H MT12202D	-
Gedeeld	235 mm	12202F	6H MT12202F	-
Kort-Gedeeld	200 mm	12202C	6H MT12202C	-
Hoorn	100 mm	12202G	6H MT12202G	-

Radius 0.6 mm

	Lengte	Bestelnummer		Gewicht
Lang	415 mm	12602A	6H MT12602A	11.30 kg
Kort	300 mm	12602D	6H MT12602D	-
Gedeeld	235 mm	12602F	6H MT12602F	-
Kort-Gedeeld	200 mm	12602C	6H MT12602C	-
Hoorn	100 mm	12602G	6H MT12602G	-

## 90° Standaard bovenstempel - MT 12

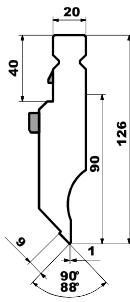

Hoek	90°
Hoogte	90.00 mm
Belasting	800 kN/m
Ear pressure	450 kN/m
Materiaal	
Hardheid	52 - 56 HRC

Radius 0.2 mm

	Lengte	Bestelnummer		Gewicht
Lang	415 mm	12200A	6H MT12200A	8.50 kg
Kort	300 mm	12200D	6H MT12200D	-
Gedeeld	235 mm	12200F	6H MT12200F	-
Kort-Gedeeld	200 mm	12200C	6H MT12200C	-
Hoorn	100 mm	12200G	6H MT12200G	-

Radius 0.6 mm

	Lengte	Bestelnummer		Gewicht
Lang	415 mm	12600A	6H MT12600A	8.50 kg
Kort	300 mm	12600D	6H MT12600D	-
Gedeeld	235 mm	12600F	6H MT12600F	-
Kort-Gedeeld	200 mm	12600C	6H MT12600C	-
Hoorn	100 mm	12600G	6H MT12600G	-

## 90° Standaard bovenstempel - MT 14

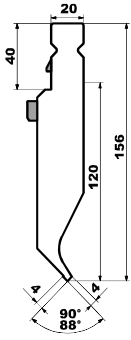

Hoek	90°
Hoogte	120.00 mm
Belasting	200 kN/m
Ear pressure	200 kN/m
Materiaal	
Hardheid	52 - 56 HRC

Radius 0.2 mm

	Lengte	Bestelnummer		Gewicht
Lang	415 mm	14202A	6H MT14202A	10.90 kg
Kort	300 mm	14202D	6H MT14202D	-
Gedeeld	235 mm	14202F	6H MT14202F	-
Kort-Gedeeld	200 mm	14202C	6H MT14202C	-
Hoorn	100 mm	14202G	6H MT14202G	-

Radius 0.6 mm

	Lengte	Bestelnummer		Gewicht
Lang	415 mm	14602A	6H MT14602A	10.90 kg
Kort	300 mm	14602D	6H MT14602D	-
Gedeeld	235 mm	14602F	6H MT14602F	-
Kort-Gedeeld	200 mm	14602C	6H MT14602C	-
Hoorn	100 mm	14602G	6H MT14602G	-

## 90° Standaard bovenstempel - MT 14

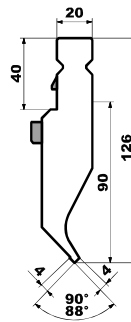

Hoek	90°
Hoogte	90.00 mm
Belasting	200 kN/m
Ear pressure	200 kN/m
Materiaal	
Hardheid	52 - 56 HRC

Radius 0.2 mm

	Lengte	Bestelnummer		Gewicht
Lang	415 mm	14200A	6H MT14200A	8.20 kg
Kort	300 mm	14200D	6H MT14200D	-
Gedeeld	235 mm	14200F	6H MT14200F	-
Kort-Gedeeld	200 mm	14200C	6H MT14200C	-
Hoorn	100 mm	14200G	6H MT14200G	-

Radius 0.6 mm

	Lengte	Bestelnummer		Gewicht
Lang	415 mm	14600A	6H MT14600A	8.20 kg
Kort	300 mm	14600D	6H MT14600D	-
Gedeeld	235 mm	14600F	6H MT14600F	-
Kort-Gedeeld	200 mm	14600C	6H MT14600C	-
Hoorn	100 mm	14600G	6H MT14600G	-

## 90° Spits bovenstempel - MT 30 (Straight Punch)

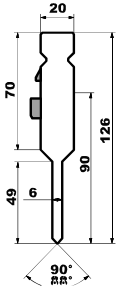

Hoek	90°
Hoogte	90.00 mm
Belasting	500 kN/m
Ear pressure	190 kN/m
Materiaal	
Hardheid	52 - 56 HRC

Radius 0.2 mm

	Lengte	Bestelnummer		Gewicht
Lang	415 mm	30200A	6H MT30200A	5.70 kg
Kort	300 mm	30200D	6H MT30200D	-
Gedeeld	235 mm	30200F	6H MT30200F	-
Kort-Gedeeld	200 mm	30200C	6H MT30200C	-
Hoorn	100 mm	30200G	6H MT30200G	-

Radius 0.6 mm

	Lengte	Bestelnummer		Gewicht
Lang	415 mm	30600A	6H MT30600A	5.70 kg
Kort	300 mm	30600D	6H MT30600D	-
Gedeeld	235 mm	30600F	6H MT30600F	-
Kort-Gedeeld	200 mm	30600C	6H MT30600C	-
Hoorn	100 mm	30600G	6H MT30600G	-

## 90° Standaard bovenstempel - MT 10

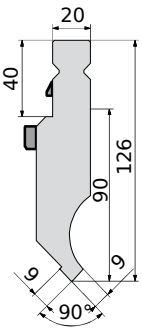

Hoek	90°
Hoogte	90.00 mm
Belasting	1000 kN/m
Ear pressure	450 kN/m
Materiaal	
Hardheid	52 - 56 HRC

Radius 0.2 mm

	Lengte	Bestelnummer		Gewicht
Lang	415 mm	10200A	6H MT10200A	8.60 kg
Kort	300 mm	10200D	6H MT10200D	-
Gedeeld	235 mm	10200F	6H MT10200F	-
Kort-Gedeeld	200 mm	10200C	6H MT10200C	-
Hoorn	100 mm	10200G	6H MT10200G	-

Radius 0.6 mm

	Lengte	Bestelnummer		Gewicht
Lang	415 mm	10600A	6H MT10600A	8.60 kg
Kort	300 mm	10600D	6H MT10600D	-
Gedeeld	235 mm	10600F	6H MT10600F	-
Kort-Gedeeld	200 mm	10600C	6H MT10600C	-
Hoorn	100 mm	10600G	6H MT10600G	-



## 90° Standaard bovenstempel - MT 28 (splayed)

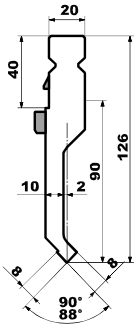

Hoek	90°
Hoogte	90.00 mm
Belasting	300 kN/m
Ear pressure	300 kN/m
Materiaal	
Hardheid	52 - 56 HRC

Radius 0.2 mm

	Lengte	Bestelnummer		Gewicht
Lang	415 mm	28200A	6H MT28200A	5.90 kg
Kort	300 mm	28200D	6H MT28200D	-
Gedeeld	235 mm	28200F	6H MT28200F	-
Kort-Gedeeld	200 mm	28200C	6H MT28200C	-
Hoorn	100 mm	28200G	6H MT28200G	-

Radius 0.6 mm

	Lengte	Bestelnummer		Gewicht
Lang	415 mm	28600A	6H MT28600A	5.90 kg
Kort	300 mm	28600D	6H MT28600D	-
Gedeeld	235 mm	28600F	6H MT28600F	-
Kort-Gedeeld	200 mm	28600C	6H MT28600C	-
Hoorn	100 mm	28600G	6H MT28600G	-

## 90° Zwanenhals bovenstempel - MT 47

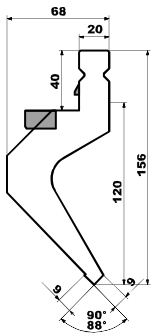

Hoek	90°
Hoogte	150.00 mm
Belasting	500 kN/m
Ear pressure	500 kN/m
Materiaal	
Hardheid	52 - 56 HRC

Radius 0.2 mm

	Lengte	Bestelnummer		Gewicht
Lang	835 mm	1A5111	1A5111	-
Kort	415 mm	1A5112	1A5112	-
Gedeeld	835 mm	1A511A	1A511A	-

## 90° Spits bovenstempel - MT 30 (Straight Punch)

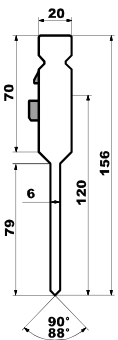

Hoek	90°
Hoogte	120.00 mm
Belasting	500 kN/m
Ear pressure	190 kN/m
Materiaal	
Hardheid	52 - 56 HRC

Radius 0.2 mm

	Lengte	Bestelnummer		Gewicht
Lang	415 mm	30202A	6H MT30202A	6.30 kg
Kort	300 mm	30202D	6H MT30202D	-
Gedeeld	235 mm	30202F	6H MT30202F	-
Kort-Gedeeld	200 mm	30202C	6H MT30202C	-
Hoorn	100 mm	30202G	6H MT30202G	-

Radius 0.6 mm

	Lengte	Bestelnummer		Gewicht
Lang	415 mm	30602A	6H MT30602A	6.30 kg
Kort	300 mm	30602D	6H MT30602D	-
Gedeeld	235 mm	30602F	6H MT30602F	-
Kort-Gedeeld	200 mm	30602C	6H MT30602C	-
Hoorn	100 mm	30602G	6H MT30602G	-

## 90° Spits bovenstempel - MT 30 (Straight Punch)

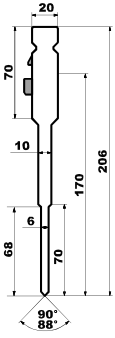

Hoek	90°
Hoogte	170.00 mm
Belasting	500 kN/m
Ear pressure	190 kN/m
Materiaal	
Hardheid	52 - 56 HRC

Radius 0.2 mm

	Lengte	Bestelnummer		Gewicht
Lang	415 mm	30207A	6H MT30207A	8.10 kg
Kort	300 mm	30207D	6H MT30207D	-
Gedeeld	235 mm	30207F	6H MT30207F	-
Kort-Gedeeld	200 mm	30207C	6H MT30207C	-
Hoorn	100 mm	30207G	6H MT30207G	-

Radius 0.6 mm

	Lengte	Bestelnummer		Gewicht
Lang	415 mm	30607A	6H MT30607A	8.10 kg
Kort	300 mm	30607D	6H MT30607D	-
Gedeeld	235 mm	30607F	6H MT30607F	-
Kort-Gedeeld	200 mm	30607C	6H MT30607C	-
Hoorn	100 mm	30607G	6H MT30607G	-

## 90° Standaard bovenstempel - MT 10

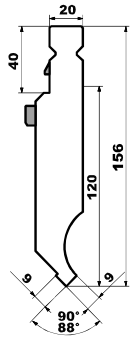

Hoek	90°
Hoogte	120.00 mm
Belasting	1000 kN/m
Ear pressure	450 kN/m
Materiaal	
Hardheid	52 - 56 HRC

Radius 0.2 mm

	Lengte	Bestelnummer		Gewicht
Lang	415 mm	10202A	6H MT10202A	11.40 kg
Kort	300 mm	10202D	6H MT10202D	-
Gedeeld	235 mm	10202F	6H MT10202F	-
Kort-Gedeeld	200 mm	10202C	6H MT10202C	-
Hoorn	100 mm	10202G	6H MT10202G	-

Radius 0.6 mm

	Lengte	Bestelnummer		Gewicht
Lang	415 mm	10602A	6H MT10602A	11.40 kg
Kort	300 mm	10602D	6H MT10602D	-
Gedeeld	235 mm	10602F	6H MT10602F	-
Kort-Gedeeld	200 mm	10602C	6H MT10602C	-
Hoorn	100 mm	10602G	6H MT10602G	-

## 90° Standaard bovenstempel - MT 28 (splayed)

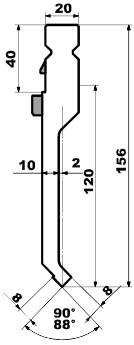

Hoek	90°
Hoogte	120.00 mm
Belasting	300 kN/m
Ear pressure	300 kN/m
Materiaal	
Hardheid	52 - 56 HRC

Radius 0.2 mm

	Lengte	Bestelnummer		Gewicht
Lang	415 mm	28202A	6H MT28202A	6.90 kg
Kort	300 mm	28202D	6H MT28202D	-
Gedeeld	235 mm	28202F	6H MT28202F	-
Kort-Gedeeld	200 mm	28202C	6H MT28202C	-
Hoorn	100 mm	28202G	6H MT28202G	-

Radius 0.6 mm

	Lengte	Bestelnummer		Gewicht
Lang	415 mm	28602A	6H MT28602A	6.90 kg
Kort	300 mm	28602D	6H MT28602D	-
Gedeeld	235 mm	28602F	6H MT28602F	-
Kort-Gedeeld	200 mm	28602C	6H MT28602C	-
Hoorn	100 mm	28602G	6H MT28602G	-

## 90° Standaard bovenstempel - MT 40

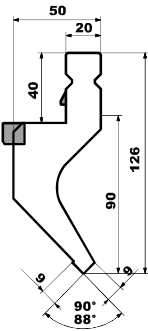

Hoek	90°
Hoogte	90.00 mm
Belasting	700 kN/m
Ear pressure	500 kN/m
Materiaal	
Hardheid	52 - 56 HRC

Radius 0.2 mm

	Lengte	Bestelnummer		Gewicht
Lang	415 mm	40200A	6H MT40200A	9.60 kg
Kort	300 mm	40200D	6H MT40200D	-
Gedeeld	235 mm	40200F	6H MT40200F	-
Kort-Gedeeld	200 mm	40200C	6H MT40200C	-
Hoorn	100 mm	40200G	6H MT40200G	-

Radius 0.6 mm

	Lengte	Bestelnummer		Gewicht
Lang	415 mm	40600A	6H MT40600A	9.60 kg
Kort	300 mm	40600D	6H MT40600D	-
Gedeeld	235 mm	40600F	6H MT40600F	-
Kort-Gedeeld	200 mm	40600C	6H MT40600C	-
Hoorn	100 mm	40600G	6H MT40600G	-

## 90° Zwanenhals bovenstempel - MT 46

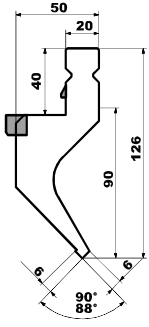

Hoek	90°
Hoogte	90.00 mm
Belasting	500 kN/m
Ear pressure	350 kN/m
Materiaal	
Hardheid	52 - 56 HRC

Radius 0.2 mm

	Lengte	Bestelnummer		Gewicht
Lang	415 mm	46200A	6H MT46200A	9.10 kg
Kort	300 mm	46200D	6H MT46200D	-
Gedeeld	235 mm	46200F	6H MT46200F	-
Kort-Gedeeld	200 mm	46200C	6H MT46200C	-
Hoorn	100 mm	46200G	6H MT46200G	-

Radius 0.6 mm

	Lengte	Bestelnummer		Gewicht
Lang	415 mm	46600A	6H MT46600A	9.10 kg
Kort	300 mm	46600D	6H MT46600D	-
Gedeeld	235 mm	46600F	6H MT46600F	-
Kort-Gedeeld	200 mm	46600C	6H MT46600C	-
Hoorn	100 mm	46600G	6H MT46600G	-

## 90° Standaard bovenstempel - MT 28 (splayed)

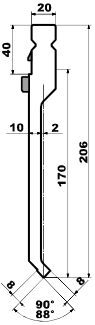

Hoek	90°
Hoogte	170.00 mm
Belasting	300 kN/m
Ear pressure	300 kN/m
Materiaal	
Hardheid	52 - 56 HRC

Radius 0.2 mm

	Lengte	Bestelnummer		Gewicht
Lang	415 mm	28207A	6H MT28207A	8.60 kg
Kort	300 mm	28207D	6H MT28207D	-
Gedeeld	235 mm	28207F	6H MT28207F	-
Kort-Gedeeld	200 mm	28207C	6H MT28207C	-
Hoorn	100 mm	28207G	6H MT28207G	-

Radius 0.6 mm

	Lengte	Bestelnummer		Gewicht
Lang	415 mm	28607A	6H MT28607A	8.60 kg
Kort	300 mm	28607D	6H MT28607D	-
Gedeeld	235 mm	28607F	6H MT28607F	-
Kort-Gedeeld	200 mm	28607C	6H MT28607C	-
Hoorn	100 mm	28607G	6H MT28607G	-

## 90° Standaard bovenstempel - MT 40

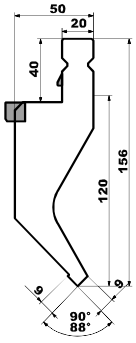

Hoek	90°
Hoogte	120.00 mm
Belasting	700 kN/m
Ear pressure	500 kN/m
Materiaal	
Hardheid	52 - 56 HRC

Radius 0.2 mm

	Lengte	Bestelnummer		Gewicht
Lang	415 mm	40202A	6H MT40202A	13.80 kg
Kort	300 mm	40202D	6H MT40202D	-
Gedeeld	235 mm	40202F	6H MT40202F	-
Kort-Gedeeld	200 mm	40202C	6H MT40202C	-
Hoorn	100 mm	40202G	6H MT40202G	-

Radius 0.6 mm

	Lengte	Bestelnummer		Gewicht
Lang	415 mm	40602A	6H MT40602A	13.80 kg
Kort	300 mm	40602D	6H MT40602D	-
Gedeeld	235 mm	40602F	6H MT40602F	-
Kort-Gedeeld	200 mm	40602C	6H MT40602C	-
Hoorn	100 mm	40602G	6H MT40602G	-

## 90° Zwanenhals bovenstempel - MT 46

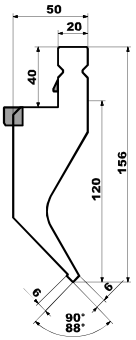

Hoek	90°
Hoogte	120.00 mm
Belasting	500 kN/m
Ear pressure	350 kN/m
Materiaal	
Hardheid	52 - 56 HRC

Radius 0.2 mm

	Lengte	Bestelnummer		Gewicht
Lang	415 mm	46202A	6H MT46202A	13.30 kg
Kort	300 mm	46202D	6H MT46202D	-
Gedeeld	235 mm	46202F	6H MT46202F	-
Kort-Gedeeld	200 mm	46202C	6H MT46202C	-
Hoorn	100 mm	46202G	6H MT46202G	-

Radius 0.6 mm

	Lengte	Bestelnummer		Gewicht
Lang	415 mm	46602A	6H MT46602A	13.30 kg
Kort	300 mm	46602D	6H MT46602D	-
Gedeeld	235 mm	46602F	6H MT46602F	-
Kort-Gedeeld	200 mm	46602C	6H MT46602C	-
Hoorn	100 mm	46602G	6H MT46602G	-

## 1V Matrijs - (V6 / 30°)

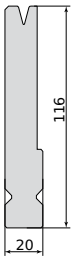

	V6 x 30° / (R 1.00 mm)
Hoogte	116.00 mm
Breedte	17.00 mm
Belasting	180 kN/m
Materiaal	
Hardheid	52 - 56 HRC Onbehandeld
Installation	Snelwisselsysteem

	Lengte	Bestelnummer		Gewicht
Lang	415 mm	50638E	6H MT50638E	6.60 kg
Kort	300 mm	50638D	6H MT50638D	-
Gedeeld	235 mm	50638F	6H MT50638F	-
Kort-Gedeeld	200 mm	50638C	6H MT50638C	-

## 1V Matrijs - (V8 / 30°)

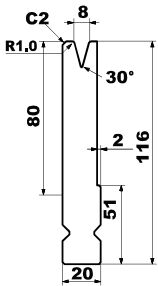

	V8 x 30° / (R 1.00 mm)
Hoogte	116.00 mm
Breedte	18.00 mm
Belasting	200 kN/m
Materiaal	
Hardheid	52 - 56 HRC Onbehandeld
Installation	Snelwisselsysteem

	Lengte	Bestelnummer		Gewicht
Lang	415 mm	50838E	6H MT50838E	6.80 kg
Kort	300 mm	50838D	6H MT50838D	-
Gedeeld	235 mm	50838F	6H MT50838F	-
Kort-Gedeeld	200 mm	50838C	6H MT50838C	-

## 1V Matrijs - (V10 / 30°)

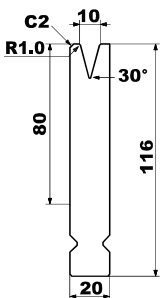

	V10 x 30° / (R 1.00 mm)
Hoogte	116.00 mm
Breedte	20.00 mm
Belasting	260 kN/m
Materiaal	
Hardheid	52 - 56 HRC Onbehandeld
Installation	Snelwisselsysteem

	Lengte	Bestelnummer		Gewicht
Lang	415 mm	51038E	6H MT51038E	7.10 kg
Kort	300 mm	51038D	6H MT51038D	-
Gedeeld	235 mm	51038F	6H MT51038F	-
Kort-Gedeeld	200 mm	51038C	6H MT51038C	-

## 1V Matrijs - (V4 / 88°)

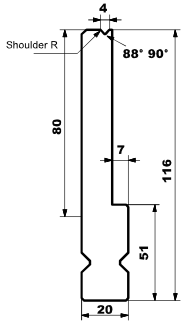

	V4 x 88° / (R 0.00 mm)
Hoogte	116.00 mm
Breedte	13.00 mm
Belasting	400 kN/m
Materiaal	
Hardheid	52 - 56 HRC Onbehandeld
Installation	Snelwisselsysteem

	Lengte	Bestelnummer		Gewicht
Lang	415 mm	60488E	6H MT60488E	5.70 kg
Kort	300 mm	60488D	6H MT60488D	-
Gedeeld	235 mm	60488F	6H MT60488F	-
Kort-Gedeeld	200 mm	60488C	6H MT60488C	-

## 1V Matrijs - (V4 / 88°)

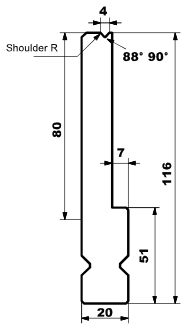

	V4 x 88° / (R 1.00 mm)
Hoogte	116.00 mm
Breedte	13.00 mm
Belasting	400 kN/m
Materiaal	
Hardheid	52 - 56 HRC Onbehandeld
Installation	Snelwisselsysteem

	Lengte	Bestelnummer		Gewicht
Lang	415 mm	70488E	6H MT70488E	5.70 kg
Kort	300 mm	70488D	6H MT70488D	-
Gedeeld	235 mm	70488F	6H MT70488F	-
Kort-Gedeeld	200 mm	70488C	6H MT70488C	-

## 1V Matrijs - (V5 / 88°)

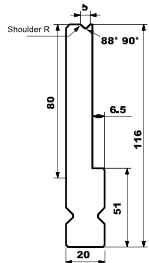

	V5 x 88° / (R 0.00 mm)
Hoogte	116.00 mm
Breedte	13.50 mm
Belasting	500 kN/m
Materiaal	
Hardheid	52 - 56 HRC Onbehandeld
Installation	Snelwisselsysteem

	Lengte	Bestelnummer		Gewicht
Lang	415 mm	60588E	6H MT60588E	5.80 kg
Kort	300 mm	60588D	6H MT60588D	-
Gedeeld	235 mm	60588F	6H MT60588F	-
Kort-Gedeeld	200 mm	60588C	6H MT60588C	-

## 1V Matrijs - (V5 / 88°)

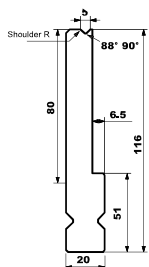

	V5 x 88° / (R 1.00 mm)
Hoogte	116.00 mm
Breedte	13.50 mm
Belasting	500 kN/m
Materiaal	
Hardheid	52 - 56 HRC Onbehandeld
Installation	Snelwisselsysteem

	Lengte	Bestelnummer		Gewicht
Lang	415 mm	70588E	6H MT70588E	5.80 kg
Kort	300 mm	70588D	6H MT70588D	-
Gedeeld	235 mm	70588F	6H MT70588F	-
Kort-Gedeeld	200 mm	70588C	6H MT70588C	-

## 1V Matrijs - (V6 / 88°)

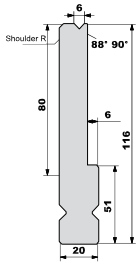

	V6 x 88° / (R 0.00 mm)
Hoogte	116.00 mm
Breedte	14.00 mm
Belasting	550 kN/m
Materiaal	
Hardheid	52 - 56 HRC Onbehandeld
Installation	Snelwisselsysteem

	Lengte	Bestelnummer		Gewicht
Lang	415 mm	60688E	6H MT60688E	6.00 kg
Kort	300 mm	60688D	6H MT60688D	-
Gedeeld	235 mm	60688F	6H MT60688F	-
Kort-Gedeeld	200 mm	60688C	6H MT60688C	-

## 1V Matrijs - (V6 / 88°)

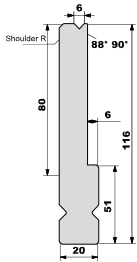

	V6 x 88° / (R 1.00 mm)
Hoogte	116.00 mm
Breedte	14.00 mm
Belasting	550 kN/m
Materiaal	
Hardheid	52 - 56 HRC Onbehandeld
Installation	Snelwisselsysteem

	Lengte	Bestelnummer		Gewicht
Lang	415 mm	70688E	6H MT70688E	6.00 kg
Kort	300 mm	70688D	6H MT70688D	-
Gedeeld	235 mm	70688F	6H MT70688F	-
Kort-Gedeeld	200 mm	70688C	6H MT70688C	-

## 1V Matrijs - (V7 / 88°)

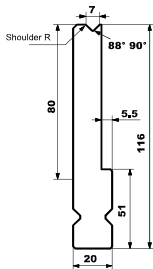

	V7 x 88° / (R 0.00 mm)
Hoogte	116.00 mm
Breedte	14.50 mm
Belasting	600 kN/m
Materiaal	
Hardheid	52 - 56 HRC Onbehandeld
Installation	Snelwisselsysteem

	Lengte	Bestelnummer		Gewicht
Lang	415 mm	60788E	6H MT60788E	6.10 kg
Kort	300 mm	60788D	6H MT60788D	-
Gedeeld	235 mm	60788F	6H MT60788F	-
Kort-Gedeeld	200 mm	60788C	6H MT60788C	-

## 1V Matrijs - (V7 / 88°)

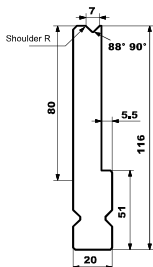

	V7 x 88° / (R 1.00 mm)
Hoogte	116.00 mm
Breedte	14.50 mm
Belasting	600 kN/m
Materiaal	
Hardheid	52 - 56 HRC Onbehandeld
Installation	Snelwisselsysteem

	Lengte	Bestelnummer		Gewicht
Lang	415 mm	70788E	6H MT70788E	6.10 kg
Kort	300 mm	70788D	6H MT70788D	-
Gedeeld	235 mm	70788F	6H MT70788F	-
Kort-Gedeeld	200 mm	70788C	6H MT70788C	-



## 1V Matrijs - (V8 / 88°)

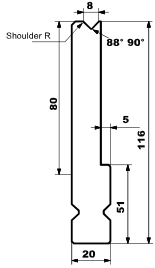

	V8 x 88° / (R 0.00 mm)
Hoogte	116.00 mm
Breedte	15.00 mm
Belasting	650 kN/m
Materiaal	
Hardheid	52 - 56 HRC Onbehandeld
Installation	Snelwisselsysteem

	Lengte	Bestelnummer		Gewicht
Lang	415 mm	60888E	6H MT60888E	6.20 kg
Kort	300 mm	60888D	6H MT60888D	-
Gedeeld	235 mm	60888F	6H MT60888F	-
Kort-Gedeeld	200 mm	60888C	6H MT60888C	-

## 1V Matrijs - (V8 / 88°)

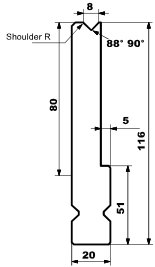

	V8 x 88° / (R 1.00 mm)
Hoogte	116.00 mm
Breedte	15.00 mm
Belasting	650 kN/m
Materiaal	
Hardheid	52 - 56 HRC Onbehandeld
Installation	Snelwisselsysteem

	Lengte	Bestelnummer		Gewicht
Lang	415 mm	70888E	6H MT70888E	6.20 kg
Kort	300 mm	70888D	6H MT70888D	-
Gedeeld	235 mm	70888F	6H MT70888F	-
Kort-Gedeeld	200 mm	70888C	6H MT70888C	-

## 1V Matrijs - (V10 / 88°)

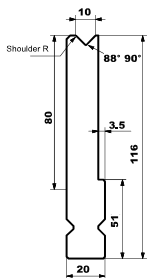

	V10 x 88° / (R 0.00 mm)
Hoogte	116.00 mm
Breedte	16.50 mm
Belasting	900 kN/m
Materiaal	
Hardheid	52 - 56 HRC Onbehandeld
Installation	Snelwisselsysteem

	Lengte	Bestelnummer		Gewicht
Lang	415 mm	61088E	6H MT61088E	6.50 kg
Kort	300 mm	61088D	6H MT61088D	-
Gedeeld	235 mm	61088F	6H MT61088F	-
Kort-Gedeeld	200 mm	61088C	6H MT61088C	-

## 1V Matrijs - (V10 / 88°)

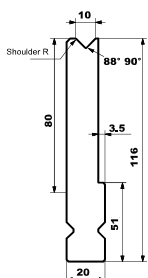

	V10 x 88° / (R 2.00 mm)
Hoogte	116.00 mm
Breedte	16.50 mm
Belasting	900 kN/m
Materiaal	
Hardheid	52 - 56 HRC Onbehandeld
Installation	Snelwisselsysteem

	Lengte	Bestelnummer		Gewicht
Lang	415 mm	71088E	6H MT71088E	6.50 kg
Kort	300 mm	71088D	6H MT71088D	-
Gedeeld	235 mm	71088F	6H MT71088F	-
Kort-Gedeeld	200 mm	71088C	6H MT71088C	-

## 1V Matrijs - (V12 / 88°)

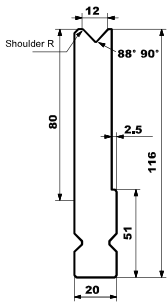

	V12 x 88° / (R 0.00 mm)
Hoogte	116.00 mm
Breedte	17.50 mm
Belasting	1000 kN/m
Materiaal	
Hardheid	52 - 56 HRC Onbehandeld
Installation	Snelwisselsysteem

	Lengte	Bestelnummer		Gewicht
Lang	415 mm	61288E	6H MT61288E	6.70 kg
Kort	300 mm	61288D	6H MT61288D	-
Gedeeld	235 mm	61288F	6H MT61288F	-
Kort-Gedeeld	200 mm	61288C	6H MT61288C	-

## 1V Matrijs - (V12 / 88°)

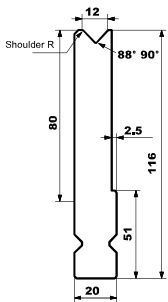

	V12 x 88° / (R 2.00 mm)
Hoogte	116.00 mm
Breedte	17.50 mm
Belasting	1000 kN/m
Materiaal	
Hardheid	52 - 56 HRC Onbehandeld
Installation	Snelwisselsysteem

	Lengte	Bestelnummer		Gewicht
Lang	415 mm	71288E	6H MT71288E	6.70 kg
Kort	300 mm	71288D	6H MT71288D	-
Gedeeld	235 mm	71288F	6H MT71288F	-
Kort-Gedeeld	200 mm	71288C	6H MT71288C	-

## 1V Matrijs - (V14 / 88°)

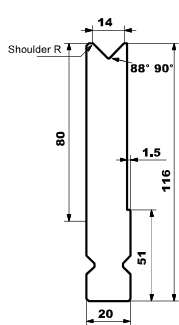

	V14 x 88° / (R 0.00 mm)
Hoogte	116.00 mm
Breedte	18.50 mm
Belasting	1000 kN/m
Materiaal	
Hardheid	52 - 56 HRC Onbehandeld
Installation	Snelwisselsysteem

	Lengte	Bestelnummer		Gewicht
Lang	415 mm	61488E	6H MT61488E	6.90 kg
Kort	300 mm	61488D	6H MT61488D	-
Gedeeld	235 mm	61488F	6H MT61488F	-
Kort-Gedeeld	200 mm	61488C	6H MT61488C	-

## 1V Matrijs - (V14 / 88°)

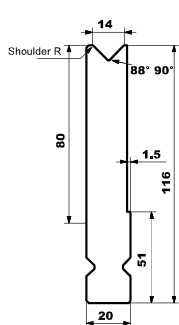

	V14 x 88° / (R 2.00 mm)
Hoogte	116.00 mm
Breedte	18.50 mm
Belasting	1000 kN/m
Materiaal	
Hardheid	52 - 56 HRC Onbehandeld
Installation	Snelwisselsysteem

	Lengte	Bestelnummer		Gewicht
Lang	415 mm	71488E	6H MT71488E	6.90 kg
Kort	300 mm	71488D	6H MT71488D	-
Gedeeld	235 mm	71488F	6H MT71488F	-
Kort-Gedeeld	200 mm	71488C	6H MT71488C	-

## 1V Matrijs - (V16 / 88°)

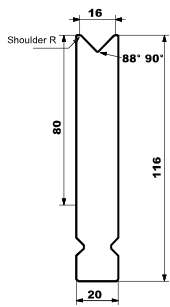

	V16 x 88° / (R 0.00 mm)
Hoogte	116.00 mm
Breedte	20.00 mm
Belasting	1000 kN/m
Materiaal	
Hardheid	52 - 56 HRC Onbehandeld
Installation	Snelwisselsysteem

	Lengte	Bestelnummer		Gewicht
Lang	415 mm	61688E	6H MT61688E	7.20 kg
Kort	300 mm	61688D	6H MT61688D	-
Gedeeld	235 mm	61688F	6H MT61688F	-
Kort-Gedeeld	200 mm	61688C	6H MT61688C	-

## 1V Matrijs - (V16 / 88°)

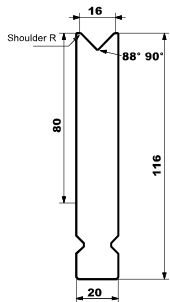

	V16 x 88° / (R 2.00 mm)
Hoogte	116.00 mm
Breedte	20.00 mm
Belasting	1000 kN/m
Materiaal	
Hardheid	52 - 56 HRC Onbehandeld
Installation	Snelwisselsysteem

	Lengte	Bestelnummer		Gewicht
Lang	415 mm	71688E	6H MT71688E	7.20 kg
Kort	300 mm	71688D	6H MT71688D	-
Gedeeld	235 mm	71688F	6H MT71688F	-
Kort-Gedeeld	200 mm	71688C	6H MT71688C	-

## 1V Matrijs - (V18 / 88°)

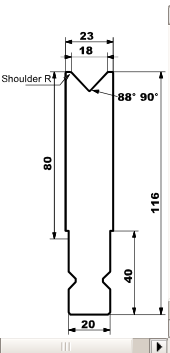

	V18 x 88° / (R 1.00 mm)
Hoogte	116.00 mm
Breedte	23.00 mm
Belasting	1000 kN/m
Materiaal	
Hardheid	52 - 56 HRC Onbehandeld
Installation	Snelwisselsysteem

	Lengte	Bestelnummer		Gewicht
Lang	415 mm	61888E	6H MT61888E	7.90 kg
Kort	300 mm	61888D	6H MT61888D	-
Gedeeld	235 mm	61888F	6H MT61888F	-
Kort-Gedeeld	200 mm	61888C	6H MT61888C	-

## 1V Matrijs - (V18 / 88°)

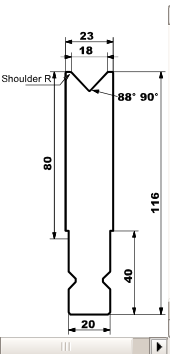

	V18 x 88° / (R 2.00 mm)
Hoogte	116.00 mm
Breedte	23.00 mm
Belasting	1000 kN/m
Materiaal	
Hardheid	52 - 56 HRC Onbehandeld
Installation	Snelwisselsysteem

	Lengte	Bestelnummer		Gewicht
Lang	415 mm	71888E	6H MT71888E	7.90 kg
Kort	300 mm	71888D	6H MT71888D	-
Gedeeld	235 mm	71888F	6H MT71888F	-
Kort-Gedeeld	200 mm	71888C	6H MT71888C	-

## 1V Matrijs - (V20 / 88°)

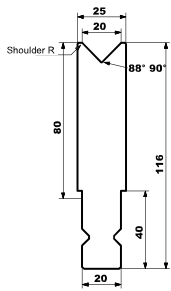

	V20 x 88° / (R 1.00 mm)
Hoogte	116.00 mm
Breedte	25.00 mm
Belasting	1000 kN/m
Materiaal	
Hardheid	52 - 56 HRC Onbehandeld
Installation	Snelwisselsysteem

	Lengte	Bestelnummer		Gewicht
Lang	415 mm	62088E	6H MT62088E	8.30 kg
Kort	300 mm	62088D	6H MT62088D	-
Gedeeld	235 mm	62088F	6H MT62088F	-
Kort-Gedeeld	200 mm	62088C	6H MT62088C	-

## 1V Matrijs - (V20 / 88°)

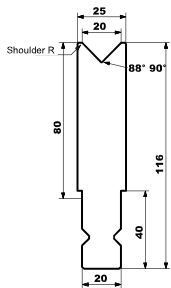

	V20 x 88° / (R 3.00 mm)
Hoogte	116.00 mm
Breedte	25.00 mm
Belasting	1000 kN/m
Materiaal	
Hardheid	52 - 56 HRC Onbehandeld
Installation	Snelwisselsysteem

	Lengte	Bestelnummer		Gewicht
Lang	415 mm	72088E	6H MT72088E	8.30 kg
Kort	300 mm	72088D	6H MT72088D	-
Gedeeld	235 mm	72088F	6H MT72088F	-
Kort-Gedeeld	200 mm	72088C	6H MT72088C	-

## 1V Matrijs - (V25 / 88°)

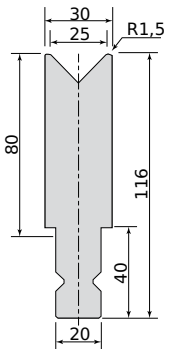

	V25 x 88° / (R 1.00 mm)
Hoogte	116.00 mm
Breedte	30.00 mm
Belasting	1000 kN/m
Materiaal	
Hardheid	52 - 56 HRC Onbehandeld
Installation	Snelwisselsysteem

	Lengte	Bestelnummer		Gewicht
Lang	415 mm	62588E	6H MT62588E	9.40 kg
Kort	300 mm	62588D	6H MT62588D	-
Gedeeld	235 mm	62588F	6H MT62588F	-
Kort-Gedeeld	200 mm	62588C	6H MT62588C	-

## 1V Matrijs - (V25 / 88°)

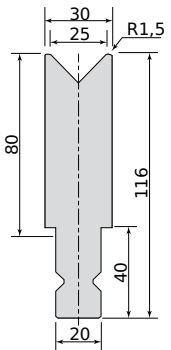

	V25 x 88° / (R 3.00 mm)
Hoogte	116.00 mm
Breedte	30.00 mm
Belasting	1000 kN/m
Materiaal	
Hardheid	52 - 56 HRC Onbehandeld
Installation	Snelwisselsysteem

	Lengte	Bestelnummer		Gewicht
Lang	415 mm	72588E	6H MT72588E	9.40 kg
Kort	300 mm	72588D	6H MT72588D	-
Gedeeld	235 mm	72588F	6H MT72588F	-
Kort-Gedeeld	200 mm	72588C	6H MT72588C	-

## 1V Matrijs - (V4 / 90°)

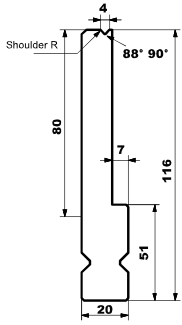

	V4 x 90° / (R 0.00 mm)
Hoogte	116.00 mm
Breedte	13.00 mm
Belasting	400 kN/m
Materiaal	
Hardheid	52 - 56 HRC Onbehandeld
Installation	Snelwisselsysteem

	Lengte	Bestelnummer		Gewicht
Lang	415 mm	60408E	6H MT60408E	5.70 kg
Kort	300 mm	60408D	6H MT60408D	-
Gedeeld	235 mm	60408F	6H MT60408F	-
Kort-Gedeeld	200 mm	60408C	6H MT60408C	-

## 1V Matrijs - (V4 / 90°)

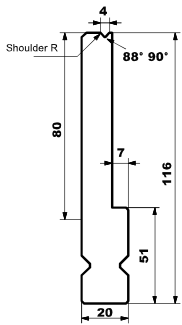

	V4 x 90° / (R 1.00 mm)
Hoogte	116.00 mm
Breedte	13.00 mm
Belasting	400 kN/m
Materiaal	
Hardheid	52 - 56 HRC Onbehandeld
Installation	Snelwisselsysteem

	Lengte	Bestelnummer		Gewicht
Lang	415 mm	70408E	6H MT70408E	5.70 kg
Kort	300 mm	70408D	6H MT70408D	-
Gedeeld	235 mm	70408F	6H MT70408F	-
Kort-Gedeeld	200 mm	70408C	6H MT70408C	-

## 1V Matrijs - (V5 / 90°)

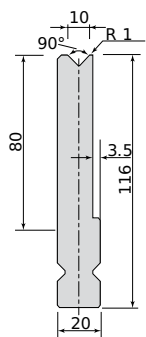

	V5 x 90° / (R 0.00 mm)
Hoogte	116.00 mm
Breedte	13.50 mm
Belasting	500 kN/m
Materiaal	
Hardheid	52 - 56 HRC Onbehandeld
Installation	Snelwisselsysteem

	Lengte	Bestelnummer		Gewicht
Lang	415 mm	60508E	6H MT60508E	5.80 kg
Kort	300 mm	60508D	6H MT60508D	-
Gedeeld	235 mm	60508F	6H MT60508F	-
Kort-Gedeeld	200 mm	60508C	6H MT60508C	-

## 1V Matrijs - (V5 / 90°)

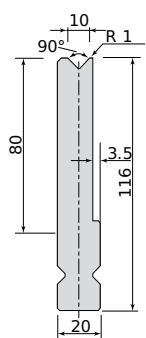

	V5 x 90° / (R 1.00 mm)
Hoogte	116.00 mm
Breedte	13.50 mm
Belasting	500 kN/m
Materiaal	
Hardheid	52 - 56 HRC Onbehandeld
Installation	Snelwisselsysteem

	Lengte	Bestelnummer		Gewicht
Lang	415 mm	70508E	6H MT70508E	5.80 kg
Kort	300 mm	70508D	6H MT70508D	-
Gedeeld	235 mm	70508F	6H MT70508F	-
Kort-Gedeeld	200 mm	70508C	6H MT70508C	-

## 1V Matrijs - (V6 / 90°)

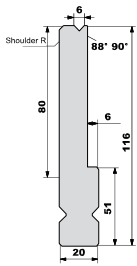

	V6 x 90° / (R 0.00 mm)
Hoogte	116.00 mm
Breedte	14.00 mm
Belasting	550 kN/m
Materiaal	
Hardheid	52 - 56 HRC Onbehandeld
Installation	Snelwisselsysteem

	Lengte	Bestelnummer		Gewicht
Lang	415 mm	60608E	6H MT60608E	6.00 kg
Kort	300 mm	60608D	6H MT60608D	-
Gedeeld	235 mm	60608F	6H MT60608F	-
Kort-Gedeeld	200 mm	60608C	6H MT60608C	-

## 1V Matrijs - (V6 / 90°)

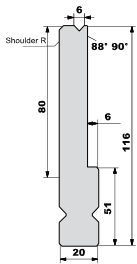

	V6 x 90° / (R 1.00 mm)
Hoogte	116.00 mm
Breedte	14.00 mm
Belasting	550 kN/m
Materiaal	
Hardheid	52 - 56 HRC Onbehandeld
Installation	Snelwisselsysteem

	Lengte	Bestelnummer		Gewicht
Lang	415 mm	70608E	6H MT70608E	6.00 kg
Kort	300 mm	70608D	6H MT70608D	-
Gedeeld	235 mm	70608F	6H MT70608F	-
Kort-Gedeeld	200 mm	70608C	6H MT70608C	-

## 1V Matrijs - (V7 / 90°)

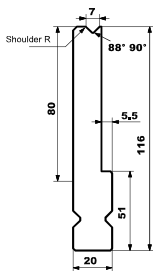

	V7 x 90° / (R 0.00 mm)
Hoogte	116.00 mm
Breedte	14.50 mm
Belasting	600 kN/m
Materiaal	
Hardheid	52 - 56 HRC Onbehandeld
Installation	Snelwisselsysteem

	Lengte	Bestelnummer		Gewicht
Lang	415 mm	60708E	6H MT60708E	6.10 kg
Kort	300 mm	60708D	6H MT60708D	-
Gedeeld	235 mm	60708F	6H MT60708F	-
Kort-Gedeeld	200 mm	60708C	6H MT60708C	-

## 1V Matrijs - (V7 / 90°)

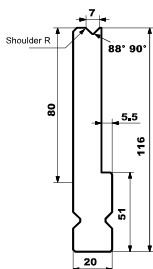

	V7 x 90° / (R 1.00 mm)
Hoogte	116.00 mm
Breedte	14.50 mm
Belasting	600 kN/m
Materiaal	
Hardheid	52 - 56 HRC Onbehandeld
Installation	Snelwisselsysteem

	Lengte	Bestelnummer		Gewicht
Lang	415 mm	70708E	6H MT70708E	6.10 kg
Kort	300 mm	70708D	6H MT70708D	-
Gedeeld	235 mm	70708F	6H MT70708F	-
Kort-Gedeeld	200 mm	70708C	6H MT70708C	-

## 1V Matrijs - (V8 / 90°)

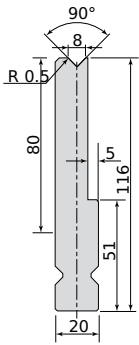

	V8 x 90° / (R 0.00 mm)
Hoogte	116.00 mm
Breedte	15.00 mm
Belasting	650 kN/m
Materiaal	
Hardheid	52 - 56 HRC Onbehandeld
Installation	Snelwisselsysteem

	Lengte	Bestelnummer		Gewicht
Lang	415 mm	60808E	6H MT60808E	6.20 kg
Kort	300 mm	60808D	6H MT60808D	-
Gedeeld	235 mm	60808F	6H MT60808F	-
Kort-Gedeeld	200 mm	60808C	6H MT60808C	-

## 1V Matrijs - (V8 / 90°)

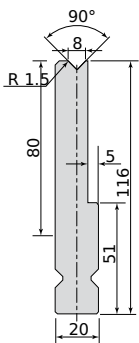

	V8 x 90° / (R 1.00 mm)
Hoogte	116.00 mm
Breedte	15.00 mm
Belasting	650 kN/m
Materiaal	
Hardheid	52 - 56 HRC Onbehandeld
Installation	Snelwisselsysteem

	Lengte	Bestelnummer		Gewicht
Lang	415 mm	70808E	6H MT70808E	6.20 kg
Kort	300 mm	70808D	6H MT70808D	-
Gedeeld	235 mm	70808F	6H MT70808F	-
Kort-Gedeeld	200 mm	70808C	6H MT70808C	-

## 1V Matrijs - (V10 / 90°)

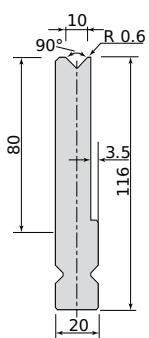

	V10 x 90° / (R 0.00 mm)
Hoogte	116.00 mm
Breedte	16.50 mm
Belasting	900 kN/m
Materiaal	
Hardheid	52 - 56 HRC Onbehandeld
Installation	Snelwisselsysteem

	Lengte	Bestelnummer		Gewicht
Lang	415 mm	61008E	6H MT61008E	6.50 kg
Kort	300 mm	61008D	6H MT61008D	-
Gedeeld	235 mm	61008F	6H MT61008F	-
Kort-Gedeeld	200 mm	61008C	6H MT61008C	-

## 1V Matrijs - (V10 / 90°)

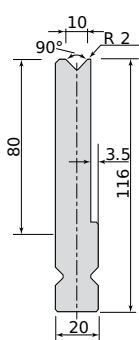

	V10 x 90° / (R 2.00 mm)
Hoogte	116.00 mm
Breedte	16.50 mm
Belasting	900 kN/m
Materiaal	
Hardheid	52 - 56 HRC Onbehandeld
Installation	Snelwisselsysteem

	Lengte	Bestelnummer		Gewicht
Lang	415 mm	71008E	6H MT71008E	6.50 kg
Kort	300 mm	71008D	6H MT71008D	-
Gedeeld	235 mm	71008F	6H MT71008F	-
Kort-Gedeeld	200 mm	71008C	6H MT71008C	-

## 1V Matrijs - (V12 / 90°)

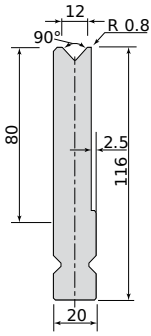

	V12 x 90° / (R 0.00 mm)
Hoogte	116.00 mm
Breedte	17.50 mm
Belasting	1000 kN/m
Materiaal	
Hardheid	52 - 56 HRC Onbehandeld
Installation	Snelwisselsysteem

	Lengte	Bestelnummer		Gewicht
Lang	415 mm	61208E	6H MT61208E	6.70 kg
Kort	300 mm	61208D	6H MT61208D	-
Gedeeld	235 mm	61208F	6H MT61208F	-
Kort-Gedeeld	200 mm	61208C	6H MT61208C	-

## 1V Matrijs - (V12 / 90°)

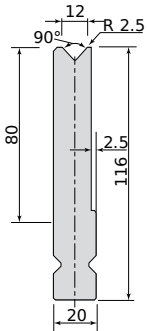

	V12 x 90° / (R 2.00 mm)
Hoogte	116.00 mm
Breedte	17.50 mm
Belasting	1000 kN/m
Materiaal	
Hardheid	52 - 56 HRC Onbehandeld
Installation	Snelwisselsysteem

	Lengte	Bestelnummer		Gewicht
Lang	415 mm	71208E	6H MT71208E	6.70 kg
Kort	300 mm	71208D	6H MT71208D	-
Gedeeld	235 mm	71208F	6H MT71208F	-
Kort-Gedeeld	200 mm	71208C	6H MT71208C	-

## 1V Matrijs - (V14 / 90°)

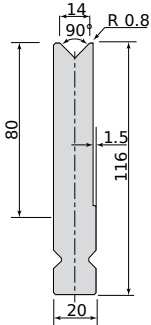

	V14 x 90° / (R 0.00 mm)
Hoogte	116.00 mm
Breedte	18.50 mm
Belasting	1000 kN/m
Materiaal	
Hardheid	52 - 56 HRC Onbehandeld
Installation	Snelwisselsysteem

	Lengte	Bestelnummer		Gewicht
Lang	415 mm	61408E	6H MT61408E	6.90 kg
Kort	300 mm	61408D	6H MT61408D	-
Gedeeld	235 mm	61408F	6H MT61408F	-
Kort-Gedeeld	200 mm	61408C	6H MT61408C	-

## 1V Matrijs - (V14 / 90°)

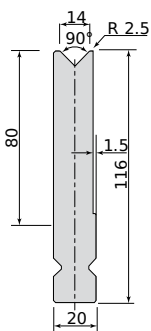

	V14 x 90° / (R 2.00 mm)
Hoogte	116.00 mm
Breedte	18.50 mm
Belasting	1000 kN/m
Materiaal	
Hardheid	52 - 56 HRC Onbehandeld
Installation	Snelwisselsysteem

	Lengte	Bestelnummer		Gewicht
Lang	415 mm	71408E	6H MT71408E	6.90 kg
Kort	300 mm	71408D	6H MT71408D	-
Gedeeld	235 mm	71408F	6H MT71408F	-
Kort-Gedeeld	200 mm	71408C	6H MT71408C	-



## 1V Matrijs - (V16 / 90°)

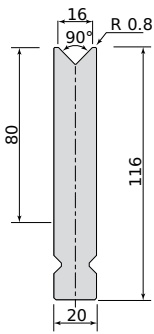

	V16 x 90° / (R 0.00 mm)
Hoogte	116.00 mm
Breedte	20.00 mm
Belasting	1000 kN/m
Materiaal	
Hardheid	52 - 56 HRC Onbehandeld
Installation	Snelwisselsysteem

	Lengte	Bestelnummer		Gewicht
Lang	415 mm	61608E	6H MT61608E	7.20 kg
Kort	300 mm	61608D	6H MT61608D	-
Gedeeld	235 mm	61608F	6H MT61608F	-
Kort-Gedeeld	200 mm	61608C	6H MT61608C	-

## 1V Matrijs - (V16 / 90°)

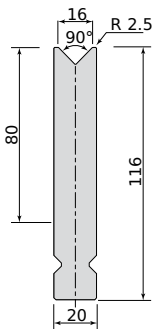

	V16 x 90° / (R 2.00 mm)
Hoogte	116.00 mm
Breedte	20.00 mm
Belasting	1000 kN/m
Materiaal	
Hardheid	52 - 56 HRC Onbehandeld
Installation	Snelwisselsysteem

	Lengte	Bestelnummer		Gewicht
Lang	415 mm	71608E	6H MT71608E	7.20 kg
Kort	300 mm	71608D	6H MT71608D	-
Gedeeld	235 mm	71608F	6H MT71608F	-
Kort-Gedeeld	200 mm	71608C	6H MT71608C	-

## 1V Matrijs - (V18 / 90°)

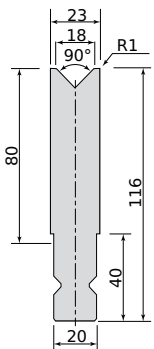

	V18 x 90° / (R 1.00 mm)
Hoogte	116.00 mm
Breedte	23.00 mm
Belasting	1000 kN/m
Materiaal	
Hardheid	52 - 56 HRC Onbehandeld
Installation	Snelwisselsysteem

	Lengte	Bestelnummer		Gewicht
Lang	415 mm	61808E	6H MT61808E	7.90 kg
Kort	300 mm	61808D	6H MT61808D	-
Gedeeld	235 mm	61808F	6H MT61808F	-
Kort-Gedeeld	200 mm	61808C	6H MT61808C	-

## 1V Matrijs - (V18 / 90°)

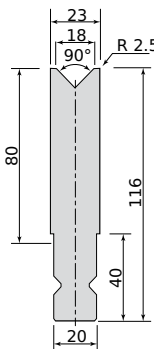

	V18 x 90° / (R 2.00 mm)
Hoogte	116.00 mm
Breedte	23.00 mm
Belasting	1000 kN/m
Materiaal	
Hardheid	52 - 56 HRC Onbehandeld
Installation	Snelwisselsysteem

	Lengte	Bestelnummer		Gewicht
Lang	415 mm	71808E	6H MT71808E	7.90 kg
Kort	300 mm	71808D	6H MT71808D	-
Gedeeld	235 mm	71808F	6H MT71808F	-
Kort-Gedeeld	200 mm	71808C	6H MT71808C	-

## 1V Matrijs - (V20 / 90°)

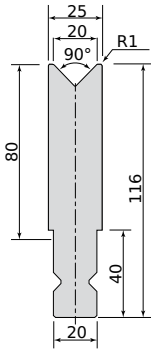

	V20 x 90° / (R 1.00 mm)
Hoogte	116.00 mm
Breedte	25.00 mm
Belasting	1000 kN/m
Materiaal	
Hardheid	52 - 56 HRC Onbehandeld
Installation	Snelwisselsysteem

	Lengte	Bestelnummer		Gewicht
Lang	415 mm	62008E	6H MT62008E	8.30 kg
Kort	300 mm	62008D	6H MT62008D	-
Gedeeld	235 mm	62008F	6H MT62008F	-
Kort-Gedeeld	200 mm	62008C	6H MT62008C	-

## 1V Matrijs - (V20 / 90°)

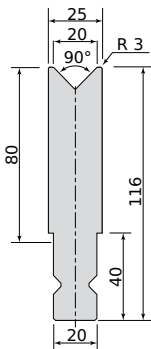

	V20 x 90° / (R 3.00 mm)
Hoogte	116.00 mm
Breedte	25.00 mm
Belasting	1000 kN/m
Materiaal	
Hardheid	52 - 56 HRC Onbehandeld
Installation	Snelwisselsysteem

	Lengte	Bestelnummer		Gewicht
Lang	415 mm	72008E	6H MT72008E	8.30 kg
Kort	300 mm	72008D	6H MT72008D	-
Gedeeld	235 mm	72008F	6H MT72008F	-
Kort-Gedeeld	200 mm	72008C	6H MT72008C	-

## 1V Matrijs - (V25 / 90°)

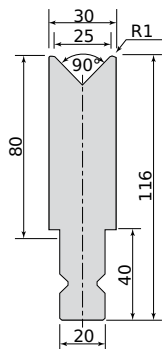

	V25 x 90° / (R 1.00 mm)
Hoogte	116.00 mm
Breedte	30.00 mm
Belasting	1000 kN/m
Materiaal	
Hardheid	52 - 56 HRC Onbehandeld
Installation	Snelwisselsysteem

	Lengte	Bestelnummer		Gewicht
Lang	415 mm	62508E	6H MT62508E	9.40 kg
Kort	300 mm	62508D	6H MT62508D	-
Gedeeld	235 mm	62508F	6H MT62508F	-
Kort-Gedeeld	200 mm	62508C	6H MT62508C	-

## 1V Matrijs - (V25 / 90°)

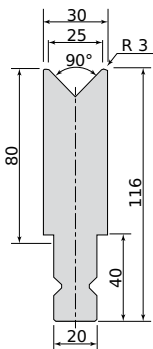

	V25 x 90° / (R 3.00 mm)
Hoogte	116.00 mm
Breedte	30.00 mm
Belasting	1000 kN/m
Materiaal	
Hardheid	52 - 56 HRC Onbehandeld
Installation	Snelwisselsysteem

	Lengte	Bestelnummer		Gewicht
Lang	415 mm	72508E	6H MT72508E	9.40 kg
Kort	300 mm	72508D	6H MT72508D	-
Gedeeld	235 mm	72508F	6H MT72508F	-
Kort-Gedeeld	200 mm	72508C	6H MT72508C	-

# Air bending force chart

## Mild steel

Die opening <b>V</b>	4	6	7	8	10	12	14	16	18	20	25	32	40	50	63	80	100	125	160	200	
Minimum flange length <b><math>b_{min}</math></b>	2.8	4	5	5.5	7	8.5	10	11	13.5	14	17.5	22	28	35	45	55	71	89	113		
Bending radius <b><math>ir</math></b>	0.7	1.0	1.1	1.3	1.6	2.0	2.3	2.6	3.0	3.3	4.0	5.0	6.5	8.0	10	13	16	20	26		
Thickness (t) →	0.5 mm	40	30																		
	0.6 mm	60	40	40	40																
	0.8 mm		70	70	50	40															
	1.0 mm		110	100	80	70															
	1.2 mm			140	120	100	80	70	60												
	1.5 mm				170	150	130	110	90	80											
	2.0 mm						220	190	170	150	130	110									
	2.5 mm								280	250	220	180	140								
	3.0 mm									340	300	240	190	150							
	3.5 mm											330	260	200	160	130					
	4.0 mm											430	340	270	210	170					
	4.5 mm												440	340	270	210					
	5.0 mm												520	420	330	260	210				
	6.0 mm												750	600	480	380	300	240			
	7.0 mm															520	410	330	260		
	8.0 mm															850	680	530	430		
9.0 mm																670	540	430			
10 mm																850	670	530	420		
12 mm																	960	780	600	550	
15 mm																			950	750	

Air bending force chart for mild steel ( $R_m \approx 450 \text{ N/mm}^2$ )

# Air bending force chart

# Stainless steel

Die opening <b>V</b>	4	6	7	8	10	12	14	16	18	20	25	32	40	50	63	80	100	125	160	200	250	
Minimum flange length <b>b</b> <i>min</i>	2.8	4	5	5.5	7	8.5	10	11	13.5	14	17.5	22	28	35	45	55	71	89	113	140	175	
Bending radius <b>ir</b>	0.7	1.0	1.1	1.3	1.6	2.0	2.3	2.6	3.0	3.3	4.0	5.0	6.5	8.0	10	13	16	20	26	33	41	
Thickness (t) →	0.5 mm	60	50																			
0.6 mm	90	60	60	60																		
0.7 mm	120	80	80	60	60																	
0.8 mm		110	110	80	70																	
0.9 mm		130	120	100	80	70																
1.0 mm		170	150	120	110	80																
1.2 mm			210	180	150	120	110	90														
1.5 mm						200	170	150	130	120												
2.0 mm						330	290	260	230	200	170											
2.5 mm								390	350	300	250	190										
3.0 mm									510	450	360	290	230									
4.0 mm										650	510	410	320	260								
5.0 mm											780	630	500	390	320							
6.0 mm												900	720	570	450	360						
8.0 mm														1020	810	650	510					
10 mm																1280	1010	800	630			
12 mm																	1440	1170	900	830		
15 mm																		1800	1410	1140		
20 mm																			2500	2080	1670	
25 mm																				3150	2550	
30 mm																						3600

Air bending force chart for stainless steel ( $R_m \approx 700 \text{ N/mm}^2$ )

---

**AMADA GmbH**

Amada Allee 1  
42781 Haan  
Duitsland

Phone: +49 2104 2126-0  
Fax: +49 2104 2126-999  
E-Mail: [info@amada.nl](mailto:info@amada.nl)  
**[www.amada.nl](http://www.amada.nl)**